

COSCO[®]
SPORTS | FITNESS

С
С
Л
Л
Л
Л
Л
Л
Л
Л



COSCO (India) Limited

ProductRange:

Sporting Goods, Fitness Equipments

COSCO is a leading Sports & Fitness Products Company in India since 1980 and Exports to many Countries Worldwide. COSCO represents many top Brands like : TRETORN (Sweden), STIGA (Sweden), Newgy (USA), JKEXER (Taiwan), Fitlux (Taiwan), JK Fitness (Taiwan) for Indian Market.

Head Office : 2/8 Roop Nagar, Delhi-110007 (INDIA)

Work Area : Factory Area-200,000+ sq. ft. in Gurugram, Haryana

Work Force : Team of Management, Sales, Service and workers of 700+

Marketing & Service : The Company has a full-fledged Marketing Division supported by Sufficient Staff and Distribution Network of around 700 Dealers covering all the States in India. We have efficient After Sales Service and provide good back up Facilities to our Customers.

R & D and Quality Control :

Committed to Quality - Its our constant endeavor to provide & delight consumers with New and Innovative Products having better Design, Engineering and Aesthetic Appeal. All products are Tested to International Standard and are Manufactured/ Sourced to make the best available.

Follow us

   /coscoindia

CONTENTS

COMMERCIAL

SEMI-COMMERCIAL EQUIPMENTS

04-15	TREADMILL
16	STAIR CLIMBER
17-24	ELLIPTICAL
25-27	UPRIGHT
28-30	RECUMBENT
31	AIR BIKE
32-33	GROUP CYCLING
34-36	ROWER

STRENGTH EQUIPMENTS

37-43	FE -WEIGHT STATIONS
44-46	IE -NON WEIGHT STATIONS
47-58	CTB -DUAL NON WEIGHT STATIONS
59-70	CSW CS - WEIGHT NON WEIGHT STATIONS
71-76	NITRO - WEIGHT STATIONS
77-83	MAGNUM - WEIGHT STATIONS
84-86	ADJ. DUAL CABLE CROSS FUNCTIONAL TRAINER
87-95	NITRO MAGNUM - NON WEIGHT STATIONS
96-102	FORCE - WEIGHT STATIONS
103-108	CANON - PLATE LOADED STATIONS
109-111	MULTI STATION GYM (IMPORTED)
112-113	CROSS FIT
114-115	MULTI STATION GYM(INDIAN)

HOME EQUIPMENTS

116-125	TREADMILLS
126-128	ELLIPTICAL
129-130	RECUMBENT
131-134	UPRIGHT
135	GROUP CYCLING
136	MANUAL TREADMILL ROWER STEPPER
137-138	HOME GYM

ACCESSORIES

139-140	BENCHES
141-143	WT. PLATES DUMBBELLS KETTLEBELLS RODS





No Motor

CRUSADE-II CURVED TREADMILL

Product Code: 42100

Curved Running Treadmill, No Motor, LCD Screen. Longer Service Life as there are No Motorised Parts. Less Friction and No Heat Generation Makes it Safer than Traditional One. Run More Naturally and Burn More Calories. Propelling Technique required to Drive the Running Belt, more Muscle Groups and Expend more Energy.

Motor	: No Motor (Less Friction and No Heat Generation Makes it Safer than Traditional One)
Display	: LCD Screen
Running Belt	: Propelling Technique to Drive the Running Belt
Running Area	: 1600 x 480 mm
Max. User Weight	: 200 Kgs.
Net Weight	: 230 Kgs.
Assembly (LxWxH)	: 2000 x 900 x 1530mm
Foldable	: No
Noise Level	: Noise Degree Below 80dB
Other Features	: Longer Service Life as there are no Motorised Parts. Run More Naturally and Burn More Calories. More Muscle Groups and Expend More Energy. Aluminium Plate insert in belt for extra longer life.





AC Motor



Emergency stop



Motor Incline



USB Port



Auto Lubrication

AC-17

Product Code: 42101

A new design Treadmill for the Elite Runner. AC-17 AC Duty Treadmill suitable for Commercial Environment. Equipped with Auto Lubrication System, ensures smooth running of the treadmill over the years. Shock Absorbed Running Deck absorbs the shock of your running impact, which can translate to less stress on your joints than running over hard surfaces.

Motor	: 3HP (6HP Peak) AC Continuous Duty
Speed Range	: 1-20km/h
Incline	: Push Button Incline 0-16%
Running Belt	: 23 x 66" (580 x 1680mm)
Display	: 7 LED Windows
Max. User Weight	: 200 Kgs.
Net Weight	: 200 Kgs.
Assembly (LxWxH)	: 2200 x 920 x 1540mm
Foldable	: Yes
Emergency Stop	: Yes
Other Features	: Auto Lubrication System , Shock Absorbed Running Deck

ELECTRONICS

Functions	: Mp3 and USB, Mobile/Water Bottle Holder, 18 Preset Programs, 4 User + 2 HRC
Displays	: Time, Speed, Distance, Pulse, Calories, Body Fat





AC Motor



Emergency stop



Motor Incline



USB Port

C-5S

Product Code: 42145

Motor	: 4HP (8HP Peak) AC Continuous Duty
Speed Range	: 1-20km/h
Incline	: Motor Incline 0-20%
Running Belt	: 23 x 63" (580 x 1600mm)
Display	: Large LED Screen Display
Max. User Weight	: 200 Kgs.
Net Weight	: 280 Kgs.
Assembly (LxWxH)	: 2320 x 950 x 1800mm
Foldable	: No
Emergency Stop	: Yes
Other Features	: Mp3 and USB ,High Grade German Make Running Belt , Backlit LED offers Reduced Energy Consumption, Better Contrast and Brightness, Greater Colour Range

ELECTRONICS

Displays	: Time, Speed, Distance, Pulse, Calories, Incline, Heart Rate
----------	---





AC Motor



Emergency stop



Motor Incline



USB Port

CX 9

Product Code: 42105

New age Design, 3.0 HP AC Duty Machine with LCD Window Displays : Speed, Distance, Time, Calories, Program, Level, Pulse, Heart Rate, Body Fat. Light Weight Aluminium Alloy Side Posts and Side Rails.

Motor : 3HP (6HP Peak) AC Continuous Duty

Speed Range : 1.0-23.8 Kph.

Incline : Auto Incline 0-18%

Running Belt : 24 x 65" (600 x 1650mm)

Display : 7" LCD Blue Backlit

Max. User Weight : 200 Kgs.

Net Weight : 225 Kgs.

Assembly (LxWxH) : 2255 x 1000 x 1465mm

Foldable : No

Emergency Stop : Yes

ELECTRONICS

Functions : USB, Emergency Stop and Bottle Holders.

Displays : Time, Speed, Distance, Pulse, Calories, Heart Rate, Incline



Available in CX-9T
(Touchscreen option)



AC Motor



Emergency stop



Motor Incline



USB Port

CX 7

Product Code: 42106

An Ergonomic design with Big Running Area and superior Inverter. Powerful 3.0 HP AC Duty Motor with Auto Incline 15%. It is equipped with 2.2 KW Inverter. Large LED Displays : Speed, Distance, Time, Calories, Program, Level, Pulse, Heart Rate, Body Fat.

Motor	: 3HP (6HP Peak) AC Continuous Duty
Speed Range	: 1.0-20 Kph.
Incline	: Auto Incline 0-15%
Running Belt	: 24 x 65" (600 x 1650mm)
Display	: 7 LED Display
Max. User Weight	: 200 Kgs.
Net Weight	: 210 Kgs.
Assembly (LxWxH)	: 2210 x 930 x 1590mm
Foldable	: No
Emergency Stop	: Yes
Other Feature	: 2.2 KW Inverter

ELECTRONICS

Functions	: 5 Preset Programs, 1 User, Backlit Buttons, Custom Program, Freewheeling, Touch Brightening
Displays	: Time, Speed, Distance, Pulse, Calories, Heart Rate, Incline





AC Motor



Emergency stop



Motor Incline



Fan



USB Port

AC 1100

Product Code: 42107

A Functional and Durable Treadmi with strong 3.0 HP AC Commercial Duty Continuous Motor. Large Running Area Facilitates Longer Working Hours in Commercial Environment. Anti Skid Side Rail Augment the Big Running Area ensures Safety during Workouts. Conveniently placed Safety Key and Handle Bar with Hand Pulse Sensors.

Motor	: 3HP (6HP Peak) AC Continuous duty
Speed Range	: 1.0-20 Kph.
Incline	: Motor Incline 0-20%
Running Belt	: 22 x 60" (560 x 1525mm)
Display	: 5 Windows + Racetrack LED
Max. User Weight	: 190 Kgs.
Net Weight	: 116 Kgs.
Assembly (LxWxH)	: 2230 x 810 x 1500mm
Foldable	: No
Emergency Stop	: Yes

ELECTRONICS

Functions	: Quick Speed/ Incline Button with FAN and Hand Pulse. Running Surface with Shock Dissipation System, 12 Pre-set Programs, 4 HRC, 3 User, Non Slip Rail, Running Surface with Shock Dissipation System, USB and Speaker
-----------	---

Displays : Speed, Distance, Time, Calories, Pulse, Body Fat





AC Motor



Emergency stop



Motor Incline



USB Port

CX 6

Product Code: 42108

New age Design, A value for money Commercial Treadmill with 3.0 HP AC Duty Continuous Machine. LCD Blue Backlit Window Displays : Speed, Distance, Time, Calories, Program, Level, Pulse, Heart Rate, Body Fat.

Motor	: 3HP (6HP Peak) AC Continuous Duty
Speed Range	: 1.0-20 Kph.
Incline	: Auto Incline 0-20%
Running Belt	: 21 x 61" (540 x 1560mm)
Display	: 7" LCD Blue Backlit
Max. User Weight	: 170 Kgs.
Net Weight	: 145 Kgs.
Assembly (LxWxH)	: 2210 x 930 x 1590mm
Foldable	: No
Emergency Stop	: Yes

ELECTRONICS

Functions	: 5 Preset Programs, 1 User, Mp3 and USB
Displays	: Time, Speed, Distance, Pulse, Calories, Heart Rate, Incline





AC Motor

Emergency stop

Motor Incline

Fan

USB Port

FITLUX 665

Product Code: 42104

FitLux 665 AC Commercial Treadmill is well designed with simplicity but equipped with all essential features required as the most value-packed commercial treadmill.

Motor : 3.0 HP (6HP Peak) AC Duty Continuous

Speed Range : 0.8-20 Kmph

Incline : Motor Incline 0-15%

Running Belt : 22 x 60" (560 x 1525mm) 2.5mm Thickness

Display : 193 x 79mm LCD with tow 16 x 11 dot matrix

Max. User Weight : 159 Kgs.

Net Weight : 127 Kgs.

Assembly (LxWxH) : 1950 x 860 x 1570mm

Foldable : Yes

Emergency Stop : Yes

ELECTRONICS

Functions : 1 Manual, 12 Pre-set, 3 User, 3 Target and 4 HRC Programs. Built-in Polar Compatible Receiver, 2.5mm textured anti-slipping Running Belt.

Displays : Speed, Distance, Time, Calories, Pulse, Program, Incline, Level, BMI



FITLUX 657 SEMI-COMMERCIAL

Product Code: 42109

Motor : 2.0 HP (4 HP Peak) AC Duty Continuous

Speed Range : 0.8-18 Kph.

Incline : Motor Incline 0-15%

Running Belt : 20 x 60" (510x 1520mm) 2.5mm Thickness

Display : 3 LCD + 2 Dot Matrix

Max. User Weight : 150 Kgs.

Net Weight : 99 Kgs.

Assembly (LxWxH) : 1810 x 810 x 1560mm

Foldable : Yes, Auto Power Fold

Emergency Stop : Yes

Other Features : Patented ASA System with 5 Cushioning Levels to protect user's Joints from Impact and Injury.

ELECTRONICS

Functions : 5 Pre-sets with 3 Level Intensity, 3 HRC, 3 Target, 12 Built-in Random Programs, Built-in Polar Compatible Heart Rate Receiver, 10w USB Charger, 2.5mm Thickness Belt ensures Longer Belt Life Span

Displays : Speed, Distance, Time, Calories, Program, Level, Lap and Pulse

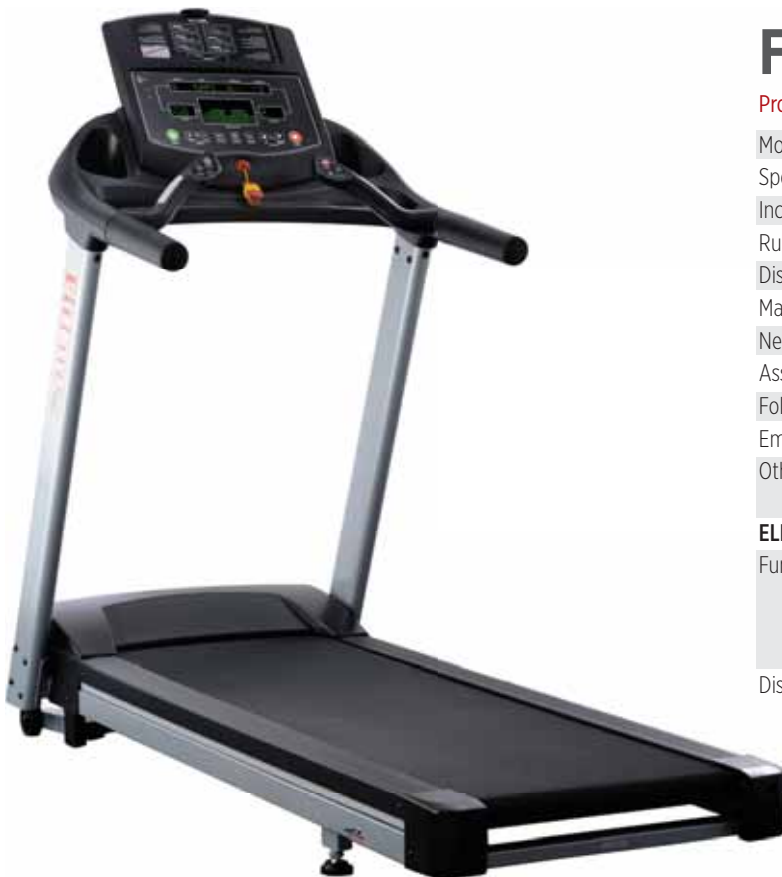

AC Motor

Emergency stop

Motor Incline

Fan

USB Port



AC Motor

Emergency stop

Motor Incline

Fan

USB Port

AC 800

Product Code: 42111

AC Motor Treadmill with (-) 3% to 15% Incline. The (-) Negative Incline to experience Walking Downhill which Develops Eccentric contractions. As you walk downhill, your body gains momentum. These eccentric contractions build strength throughout these muscles' ranges of motion. It has powerful Motor, good allround Performance in Semi-Commercial environment.

Motor	: 2.5 HP (5 HP Peak) AC Duty
Speed Range	: 1.0-18 Kph.
Incline	: -3-15% Motor Incline
Running Belt	: 20 x 55" (510 x 1400mm)
Display	: 7 LCD Display with Back Blue Light
Max. User Weight	: 150 Kgs.
Net Weight	: 108 Kgs.
Assembly (LxWxH)	: 2080 x 900 x 1460mm
Foldable	: Yes
Emergency Stop	: Yes
Other Features	: Negative Incline for Downhill walking Effect

ELECTRONICS

Functions	: 2 Layer Running Deck with Cushion, Incline Button on Handle Bar, USB and Speaker
Displays	: Speed, Distance, Time, Calories, Heart Pulse, Program





AC Motor



Emergency stop



Motor Incline



USB Port

CX-5

Product Code: 42110

Outstanding design with Wide Running Area. Best suited for Semi-Commercial use, 2.0 HP AC Motor with LED Window Displays : Speed, Distance, Time, Calories, Program, Level, Pulse, Heart Rate, Body Fat. Light Weight Aluminium Alloy Side Posts and Side Rails.

Motor : 2HP (4 HP Peak) AC Continuous Duty

Speed Range : 1.0-20.8 Kph.

Incline : Motor Incline 0-18%

Running Belt : 23 x 59" (580x1500mm)

Display : 7 LED Windows

Max. User Weight : 150 Kgs.

Net Weight : 140 Kgs.

Assembly (LxWxH) : 1956 x 1022 x 1393mm

Foldable : Yes

Emergency Stop : Yes

ELECTRONICS

Functions : Mp3 and USB, 5 Pre-set programs, 1 user

Displays : Time, Speed, Distance, Pulse, Calories, Body Fat





AC Motor

Emergency stop

Motor Incline

Fan

USB Port

AC 700

Product Code: 42112

Strong 2 HP AC Motorised Treadmill Suitable for for Semi-Commercial Environment. Double Deck Cushioning which is Highly Recommended for Comfort Level for Joints.

Motor	: 2.0 HP (4 HP Peak) AC Duty
Speed Range	: 0.1-18 Kph.
Incline	: Motor Incline 0-15%
Running Belt	: 20 x 55" (510 x 1400 mm)
Display	: 5 LED Readout
Max. User Weight	: 150 Kgs.
Net Weight	: 85 Kgs.
Assembly (LxWxH)	: 2070 x 880 x 1335mm
Foldable	: Yes
Emergency Stop	: Yes

ELECTRONICS

Functions	: 2 Layer Running Deck with Cushion, Quick Speed/ Incline Button with FAN and Hand Pulse. Running Surface with Shock Dissipation System, 12 Pre-set Programs, 4 HRC, 3 User, Anti Skid Rail. Double Cushion Deck, Wheels for Transport, MP3 and USB
Displays	: Speed, Distance, Time, Calories, Pulse, Body Fat



CTZ-2040B

STAIR CLIMBER 007

Product Code: 42299

Motor	: 1.5HP AC Duty
Step Area	: 1456cm ²
Time Display	: 0:00-99:59
Height Display	: 0:00-999.9m
Heat Display	: 0-999 (Kcal)
Level Display	: 0-15
Step No. Display	: 0-9999
Running Speed	: 24-164 Steps per Minute
Max. User Weight	: 200 Kgs.
Net Weight	: 205 Kgs.
Assembly (LxWxH)	: 1450 x 880 x 2140mm





E-70 (Made in Taiwan)

Product Code: 42601

E70 Elliptical Offers a Wonderful Workout Solution by using a Long Pedal Arm to help Exercisers to Smoothly Train the Whole Body at a Nature and Fluid Ergonomic Position, it is also Equipped with Heavy Flywheel to Maintain a Smooth Action and Ensure a Comfortable Workout.

Stride Length : 500mm

Flywheel : 242 mm (14.5 Kgs.)

Resistance Level : 40

Transmission / Ratio: V-Belt / 1:10.3

Max. User Weight : 180 Kgs.

Net Weight : 104 Kgs.

Assembly (LxWxH) : 2060 x 795 x1760 mm

ELECTRONICS

Displays : Time, Distance, METS, Pulse, Calories with 4 Pre set, 4 HRC, 1 Manual Program

Power Supply : No External Power Supply Required.

Generator : Self Generating Electronics



IMPACT-52 E

Product Code: 42602

Low Impact, smooth and natural motion results in motivating total-body workouts. Ergonomical design for a workout that feels like walking on air.

Stride Length	: 533mm
Crank	: 3 Pcs
Flywheel	: 11 Kgs.
Max. User Weight	: 160 Kgs.
Net Weight	: 114 Kgs.
Assembly (LxWxH)	: 2190 x 690 x 1880mm

ELECTRONICS

Functions	: 12 Programs
Displays	: 2 Colour Backlit LCD displays Scan, Time, Speed, Distance, Calorie, Pulse, Recovery, RPM, Manual, Watt, HRC.
Power Supply	: Self Generating Electronics. No Power Supply needed



CE-80

Product Code: 42603

CE-80 Elliptical Offers a Wonderful Workout Solution by using a Long Pedal Arm to help Exercisers to Smoothly Train the Whole Body at a Nature and Fluid Ergonomic Position, it is also Equipped with Heavy Flywheel to Maintain a Smooth Action and Ensure a Comfortable Workout.

Stride Length : 500mm

Flywheel : 242 mm (14.5 Kgs.)

Resistance Level : 1-20

Transmission | Ratio : V-Belt | 1:10.3

Max. User Weight : 180 Kgs.

Net Weight : 130 Kgs.

Assembly (LxWxH) : 2200 x 730 x 1560 mm

ELECTRONICS

Displays : Time, RPM, Distance, Pulse, METS, Calories with 4 Pre set, 4 HRC, 1 Manual Program

Power Supply : No External Power Supply Required.



ET-1000 AT*

 (Made in Taiwan)

Product Code: 42604

Friction-free Electromagnetic Resistance, Programmable Computer Button Resistance Change, Large Window LCD Readout, Console with bottle holder Ergonomically Built-in Hand Grip Pulse Sensor design, Smooth & Quiet "Belt-Drive" system, Two-Tone Wide and Custom-Moulded Foot Platform with Built-in Skid Resistant Surface, Front Transport Wheels, Dual Action Upper and Lower Body Aerobic Workout

Stride Length : 500mm

Pulley : One Way Pully Ø300mm

Crank : 3 Pcs

Max. User Weight : 130 Kgs.

Net Weight : 78 Kgs.

Assembly (LxWxH) : 1700 x 690 x 1720mm

ELECTRONICS

Displays : Speed, Distance, Time, Calories, Lap, Program, Level, Incline

*AT = Auto Tension

**STRIDE
LENGTH**

500 mm

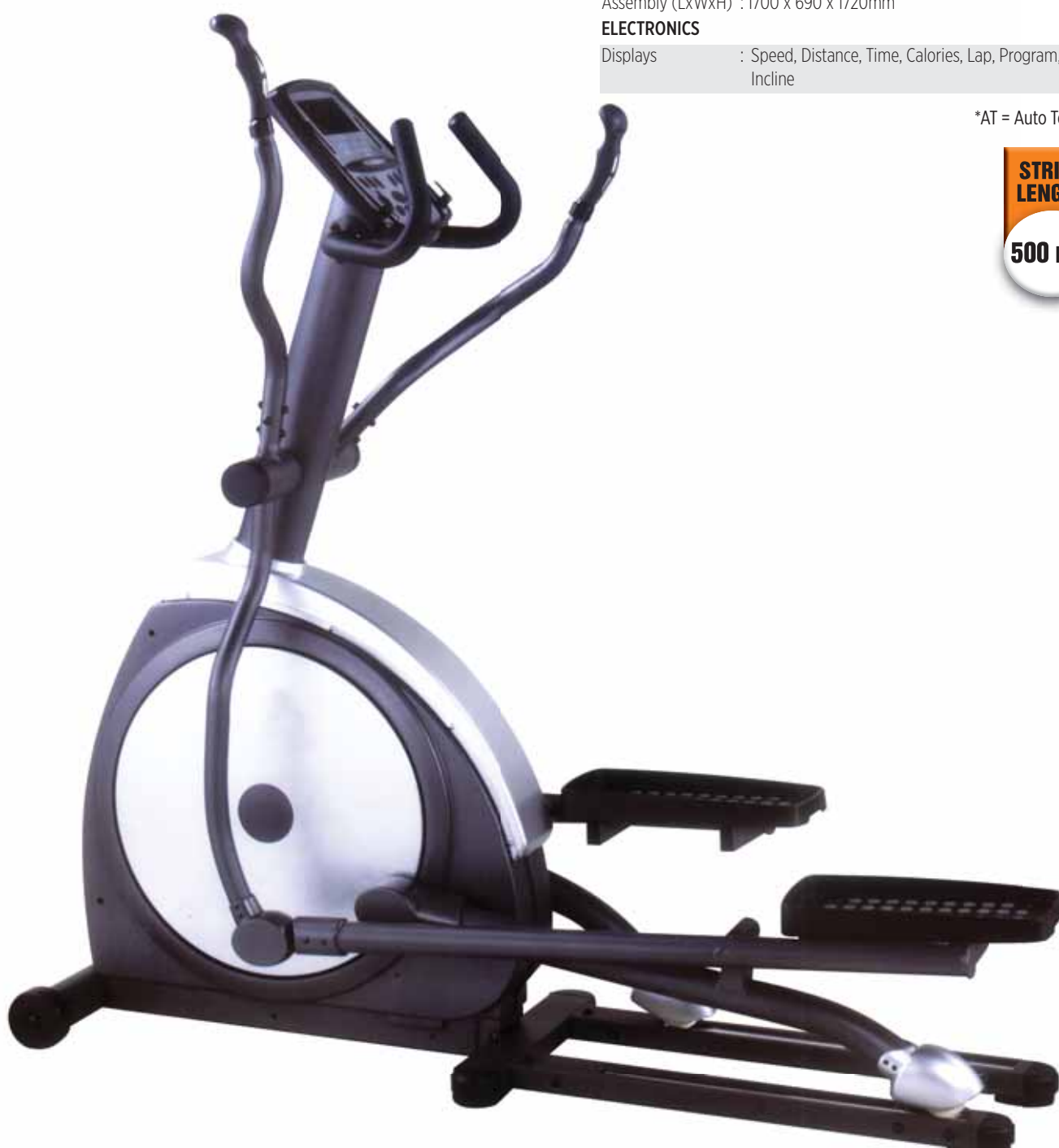

FURY 58

3 LEVEL MANUAL INCLINE

Product Code: 42613

Commercial Orbit Elliptical (EMS Magnetic System), Belt transmission system with 260 mm flywheel. Foam handlebar with resistance control buttons.

Stride Length : 500mm (20 Inches)

Meter : Touch Screen LCD display

Max. User Weight : 150 Kgs.

Net Weight : 86 Kgs.

Assembly (LxWxH) : 1721 x 724 x 1637mm

ELECTRONICS

Displays : Scan, Speed, Distance, Time, Calories, RPM



**STRIDE
LENGTH**
500 mm

CV-6E

Product Code: 42614

Motor Incline, Eddy Mechanism Flywheel

Stride Length : 500mm (20 inches)

Flywheel : 5 Kgs. Eddy Mechanism

Resistance Level : 24 Level

Max. User Weight : 150 Kgs.

Net Weight : 100 Kgs.

Assembly (LxWxH) : 1721 x 724 x 1637 mm

Other Features : Power Incline 0-15%

ELECTRONICS

Displays : Speed, Distance, Time, Calories, Pulse, Incline



**STRIDE
LENGTH**

500 mm

EX-6R

Product Code: 42615

Deluxe Elliptical Bike with 292mm dia. Flywheel. Stride Length 460mm.
Semi-Commercial Duty Elliptical with 24 Range Motorised Resistance.

Stride Length	: 460mm
Flywheel	: 292mm
Resistance Level	: 24 Range Motorised
Max. User Weight	: 120 Kgs.
Net Weight	: 57 Kgs.
Assembly (LxWxH)	: 1707 x 686 x 1625mm

ELECTRONICS

Functions	: 12 Programs with 4 HR
Displays	: Time, Speed, Distance, Pulse, Calories, Watt, Recovery

**STRIDE
LENGTH**

460 mm



IMPACT 22U

Product Code: 42301

Commercial Duty Upright Bike with Seat Slider. Self Generating Electronics. No External Power Required. This upright bike is user friendly and can be adapted to your fitness level and desired challenges. Oversized pedals and padded handlebars offer stability and support.

Crank	: 3 Pcs
Flywheel	: 11 Kgs.
Max. User Weight	: 160 Kgs.
Net Weight	: 56 Kgs.
Assembly (LxWxH)	: 1190 x 570 x 1460mm

ELECTRONICS

Functions	: Seat Slider, Hand Pulse, Bottle Holder
Displays	: Two Colour Backlit LCD Displays : Scan, Time, Speed, Distance, Calorie, Pulse, Recovery, RPM, Manual, Watt, HRC
Generator	: Self Generating Electronics



C1000 U AT* (Made in Taiwan)

Product Code: 42302

Commercial Duty Upright Bike with Ø300mm Oneway Pulley and 3 Pcs Crank. Friction Free Electromagnetic Resistance with adaptor. Deluxe Computer Console with Bottle Holder.

Pulley : One Way Pully Ø300mm

Crank : 3 Pcs

Max. User Weight : 150 Kgs.

Net Weight : 52 Kgs.

Assembly (LxWxH) : 1200 x 620 x 1500mm

ELECTRONICS

Functions : Large Windows LED Readout, Built-in Hand Grip Pulse Sensor, Durable Pedals Adjustable Strap / Strap Adjuster Buckle, Large Adjustable softer HR seat, Deluxe Computer Console with Bottle Holder

Displays : LED Readabouts

*AT=Auto Tension



CNB6.0 U-AT*

Product Code: 42330

Programmable Upright Bike with BELT DRIVE System. 260mm Dia. Flywheel. Auto Tension. Friction-free Magnetic Resistance. Deluxe computer console with book racket. Built-in Hand Grip Pulse Sensor with Elbow Pads. Two-Tones Pedals with shock resistance and adjustable strap.

Flywheel : 260mm (7 Kgs.)

Crank : 3 Pcs

Resistance Level : 16 Fitness Levels

Pulley : Ø300

Max. User Weight : 150 Kgs.

Net Weight : 46 Kgs.

Assembly (LxWxH) : 1220 x 540 x 1470mm

Other Features : Auto Tension, Pulse Recovery +BACK LIGHT

ELECTRONICS

Functions : 12 Programs

Displays : Time,RPM,Speed,Distance,Watts,Calories,H.R.C.,Body Fat,Pulse,BMI

Generator : Friction-free Magnetic Resistance.

*AT=Auto Tension

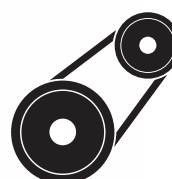

IMPACT-32 R

Product Code: 42307

Commercial Grade Recumbent Bike with Seat Slider. Self Generating Electronics. No External Power Required. This upright bike is user friendly and can be adapted to your fitness level and desired challenges. Oversized pedals and padded handlebars offer stability and support. Sturdy frame Construction.

Crank	: 3 Pcs
Flywheel	: 11 Kgs.
Max. User Weight	: 160 Kgs.
Net Weight	: 56 Kgs.
Assembly (LxWxH)	: 1190 x 570 x 1460mm

ELECTRONICS

Functions	: Seat Slider, Hand Pulse, 12 Program
Displays	: Two Colour Backlit LCD Displays : Scan, Time, Speed, Distance, Calorie, Pulse, Recovery, RPM, Manual, Watt, HRC
Generator	: Self Generating Electronics



C-1000 R AT* (Made in Taiwan)

Product Code: 42308

Commercial Duty Upright Bike with Ø300mm Oneway Pulley and 3 Pcs Crank. Friction Free Electromagnetic Resistance with adaptor. Deluxe Computer Console. Adjustable Deluxe Aluminium Carriage Tube and Seat Carriage.

Pulley : One Way Pully Ø300mm

Crank : 3 Pcs

Max. User Weight : 150 Kgs.

Net Weight : 47 Kgs.

Assembly (LxWxH) : 1450 x 620 x 1280mm

ELECTRONICS

Functions : Large Adjustable Seat & Back Cushions, Programmable Computer Features Programs with Large Windows LED Readout, Built-in Hand Grip Pulse Sensor, Durable Pedals with Shock-Absorbing Air Cushion and Adjustable Strap / Strap Adjuster Buckle, Extra Sturdy and Stable Steel Frame Construction.

Displays : LED Readabouts

*AT=Auto Tension



CNB7.0 R-AT*

Product Code: 42331

Programmable Recumbent Bike with BELT DRIVE System. Auto Tension. 260mm dia. Flywheel. Friction-free Magnetic Resistance. Deluxe computer console with book racket on the upper cover. Built-in Hand Grip Pulse Sensor. Two-Tones Pedals with shock resistance and adjustable strap. Large Adjustable Seat and Back Cushion.

Flywheel : 260mm (7 Kgs.)

Crank : 3 Pcs

Resistance Level : 16 Fitness Levels

Pulley : One Way Ø300

Max. User Weight : 150 Kgs.

Net Weight : 57 Kgs.

Assembly (LxWxH) : 1570x610x1240mm

Other Features : Auto Tension, Pulse Recovery +BACK LIGHT

ELECTRONICS

Functions : 12 Programs

Displays : Time, RPM, Speed, Distance, Watts, Calories, H.R.C.,
Body Fat, Pulse, BMI

Generator : Friction-free Magnetic Resistance.

*AT=Auto Tension

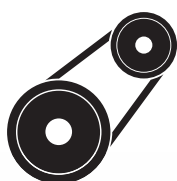

CEB-10 AIR BIKE

Product Code: 42305

Dual Drive (Belt + Chain) Magnetic Air Bike, Large Flywheel. Flat Belt, 3 Pc Crank. Aluminium SPD Pedals.

Crank : 3PCS,

Flywheel : Fan Wheel

Meter : LCD display

Max. User Weight : 150 Kgs.

Net Weight : 50 Kgs.

Assembly (LxWxH) : 1400 x 610 x 1260mm

Other Features : Chain + Belt Drive (Double Drive), 2 wheels in the front for easy transport. Adjustable Footplates, hand grip can be adjusted to fit different users, Alloy Seat, Bottle Holder

ELECTRONICS

Displays : Speed, Distance, Time, Calories, Pulse, Built in receiver, Watt

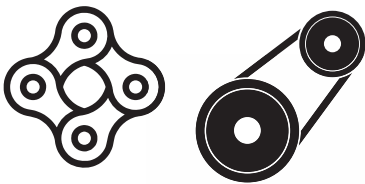

REVO 220

Product Code: 42312

New age Design, Revo 220 is a Commercial Indoor Group Cycle with Rubber Coated Handlebars Makes Users feel more Comfortable. Belt Drive System. Micro-adjustable Fore and AFT Seat Slider.

Flywheel	: 24Kgs.
Max. User Weight	: 180 Kgs.
Net Weight	: 88 Kgs.
Assembly (LxWxH)	: 1250 x 600 x 1150mm
Other Features	: High grade pedal, adjustable forward AFT. Seat, Rubber coated handle bar
ELECTRONICS	
Displays	: Time, Distance, Heart Rate

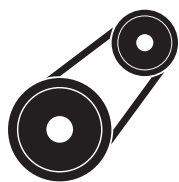

S 90

Product Code: 42313

Club workout Gropu Cycling Bike with 22 Kgs. CNC Flywheel, One-piece Belt Driven Bike. High strength axle and foot pedal which lengthen the service life. Smooth and silent when riding,

Flywheel : 22 Kgs. CNC Flywheel

Brake : Press Type

Max. User Weight : 180 Kgs.

Net Weight : 70 Kgs.

Assembly (LxWxH) : 1050 x 600 x 1150mm

Other Features : High grade pedal, adjust seat forwards & back, upward & downward, high strength axle & foot pedal, smooth & silent ride



RX 100

AIR | MAGNETIC ROWER

Product Code: 42800

The foldable RX 100 rowing machine has a double resistance system, because of this it gives the exact rowing experience and quality as the heavy air rowing machines in the gym. The heavy air system creates the base resistance and natural rowing experience. The magnetic system creates the extra exercise resistance. Ergonomic grip for added comfort. With a nice touch, you can open and close the ventilation of the air resistance as desired.

Resistance Level	: 24 Levels
Frame	: Aluminium
Max. User Weight	: 170 Kgs.
Net Weight	: 43.6 Kgs.
Assembly (LxWxH)	: 2370 x 500 x 910mm
Other Features	: Built-in Receiver, EMS Generator
ELECTRONICS	
Functions	: 43 Programs, 25 Preset, 5 User, 4 HRC, 1 Watt
Displays	: Race, Recovery, User program ,Time, Distance, Wattage, Speed, Scan, Number of Strokes, Calories, Ergometer, Body Fat, BMI Index
Display System	: LCD display



RX 99

AIR | MAGNETIC ROWER

Product Code: 42801

The foldable RX-99 rowing machine is the ideal tool to improve your cardio endurance, weight loss and strengthen a wide range of muscles. The rowing machine is equipped with an extra strong aluminum rail with a high seat. In combination with a well-designed frame, ensures that you can step on your rowing machine with complete confidence. The LCD backlight display offers a wide range of fun and inspiring programs, such as Race, Recovery, User program

Resistance Level : 16 Levels

Frame : Aluminium

Max. User Weight : 130 Kgs.

Net Weight : 36 Kgs.

Assembly (LxWxH) : 2140 x 600 x 740mm

Other Features : Polar Receiver

ELECTRONICS

Functions : 16 Programs : 12 Preset, 4 HRC, 1 User Programs

Displays : Race, Recovery, User program, Time, Distance, Speed, Number of Strokes, Calories

Adaptor : 9V 1A

Display : LCD display with backlight



CRW-6018 WATER ROWER

Product Code: 42808

Fluid resistance rower workout theory

Drag Force is physics impact data in water tank tht drag the handlebar and provide a program to produce true Watt and Calories. Drag faster more resistance.

Resistance Level	: 6 Levels
Sliding Track	: Twin tube with aluminum rail
Brake	: Water tension
Transmission System	: Volute Spring / Bungee cord
Max. User Weight	: 150 Kgs.
Net Weight	: 35 Kgs.
Assembly (LxWxH)	: 2010 x 515 x 910mm
Other Features	: Polar Receiver

ELECTRONICS

Functions	: 16 Programs : 12 Preset, 4 HRC, 1 User Programs
Displays	: Time, 500m, Spm, Drag Force, Distance S, Strokes, Total Strokes, Calories, Watt, Built in Pulse Receiver, Quick Start, Standard, Target (Interval/Single), Custom, Race
Adaptor	: Battery (2*AA)

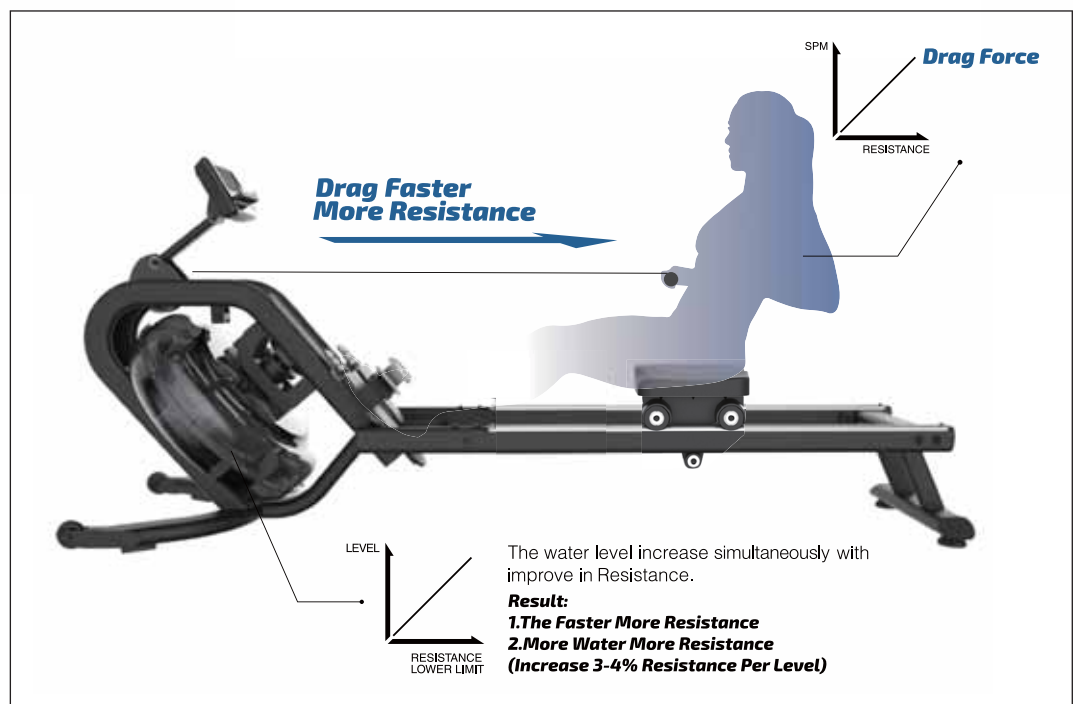



FE SERIES

FE 9710

LEG PRESS

Product Code: 43005

Size (LxWxH)	: 1785 x 1350 x 1490 mm
Net Weight	: 279 Kgs.
Weight Plates	: 235 lbs
Steel Tubing	: 72.8 x 141.7mm
Steel Thickness	: 3.0mm
Pulley Material	: Dia. 114mm MS
Weight Material	: 19 mm Full Steel Each plate weight 10 lbs
Cable	: 5 mm Dia.





FE 9701

CHEST PRESS

Product Code: 43000

Size (LxWxH)	: 1230 x 1570 x 1490 mm
Net Weight	: 169 Kgs.
Weight Plates	: 235 lbs
Steel Tubing	: 72.8 x 141.7mm
Steel Thickness	: 3.0mm
Pulley Material	: Dia. 114mm MS
Weight Material	: 19 mm Full Steel Each plate weight 10 lbs
Cable	: 5 mm Dia.



FE 9702

LAT PULL DOWN

Product Code: 43001

Size (LxWxH)	: 1305 x 1230 x 2010 mm
Net Weight	: 177 Kgs.
Weight Plates	: 235 lbs
Steel Tubing	: 72.8 x 141.7mm
Steel Thickness	: 3.0mm
Pulley Material	: Dia. 114mm MS
Weight Material	: 19 mm Full Steel Each plate weight 10 lbs
Cable	: 5 mm Dia.



FE 9703

ARM CURL

Product Code: 43002

Size (LxWxH)	: 1150 x 567 x 1490 mm
Net Weight	: 169 Kgs.
Weight Plates	: 235 lbs
Steel Tubing	: 72.8 x 141.7mm
Steel Thickness	: 3.0mm
Pulley Material	: Dia. 114mm MS
Weight Material	: 19 mm Full Steel Each plate weight 10 lbs
Cable	: 5 mm Dia.

FE 9705

LEG EXTENSION

Product Code: 43003

Size (LxWxH)	: 1300 x 1240 x 1490 mm
Net Weight	: 169 Kgs.
Weight Plates	: 235 lbs
Steel Tubing	: 72.8 x 141.7mm
Steel Thickness	: 3.0mm
Pulley Material	: Dia. 114mm MS
Weight Material	: 19 mm Full Steel Each plate weight 10 lbs
Cable	: 5 mm Dia.



FE 9706

SEATED LEG CURL

Product Code: 43004

Size (LxWxH)	: 1242 x 1541 x 1490 mm
Net Weight	: 183 Kgs.
Weight Plates	: 235 lbs
Steel Tubing	: 72.8 x 141.7mm
Steel Thickness	: 3.0mm
Pulley Material	: Dia. 114mm MS
Weight Material	: 19 mm Full Steel Each plate weight 10 lbs
Cable	: 5 mm Dia.



FE 9712

SHOULDER PRESS

Product Code: 43006

Size (LxWxH)	: 1385 x 1210 x 1490 mm
Net Weight	: 141 Kgs.
Weight Plates	: 235 lbs
Steel Tubing	: 72.8 x 141.7mm
Steel Thickness	: 3.0mm
Pulley Material	: Dia. 114mm MS
Weight Material	: 19 mm Full Steel Each plate weight 10 lbs
Cable	: 5 mm Dia.

FE 9715

PEC FLY | REAR DELT

Product Code: 43007

Size (LxWxH)	: 1296 x 1758 x 1490 mm
Net Weight	: 160 Kgs.
Weight Plates	: 235 lbs
Steel Tubing	: 72.8 x 141.7mm
Steel Thickness	: 3.0mm
Pulley Material	: Dia. 114mm MS
Weight Material	: 19 mm Full Steel Each plate weight 10 lbs
Cable	: 5 mm Dia.



FE 9719

ROW

Product Code: 43008

Size (LxWxH)	: 2000 x 1130 x 1490 mm
Net Weight	: 174 Kgs.
Weight Plates	: 235 lbs
Steel Tubing	: 72.8 x 141.7mm
Steel Thickness	: 3.0mm
Pulley Material	: Dia. 114mm MS
Weight Material	: 19 mm Full Steel Each plate weight 10 lbs
Cable	: 5 mm Dia.

FE 9720

WT. ASSISTED CHIN | DIP COMBO

Product Code: 43009

Size (LxWxH)	: 1750 x 1380 x 2200 mm
Net Weight	: 243 Kgs.
Weight Plates	: 235 lbs
Steel Tubing	: 72.8 x 141.7mm
Steel Thickness	: 3.0mm
Pulley Material	: Dia. 114mm MS
Weight Material	: 19 mm Full Steel Each plate weight 10 lbs
Cable	: 5 mm Dia.



IE SERIES



IE 7001B

SMITH MACHINE

Product Code: 43010

Size (LxWxH) : 2241 x 1326 x 2370 mm

Net Weight : 178 Kgs.

Steel Tubing : 100 x 50mm (Racetrack Tubing)

Steel Thickness : 2.75 - 2.5mm

IE 7006C

LEG PRESS | HACK SQUAT

Product Code: 43013

Size (LxWxH) : 2253 x 975 x 1475 mm

Net Weight : 166 Kgs.

Steel Tubing : 100 x 50mm (Racetrack Tubing)

Steel Thickness : 2.75 - 2.5mm





IE 7004B

STRETCH

Product Code: 43012

Size (LxWxH)	: 1274 x 552 x 997 mm
Net Weight	: 35 Kgs.
Steel Tubing	: 100 x 50mm (Racetrack Tubing)
Steel Thickness	: 2.75 - 2.5mm

IE 7003C

AB CRUNCH

Product Code: 43011

Size (LxWxH)	: 1745 x 936 x 997 mm
Net Weight	: 57 Kgs.
Steel Tubing	: 100 x 50mm (Racetrack Tubing)
Steel Thickness	: 2.75 - 2.5mm



IE 7009B

FLAT BENCH

Product Code: 43015

Size (LxWxH)	: 1200 x 781 x 1515mm
Net Weight	: 53 Kgs.
Steel Tubing	: 100 x 50mm (Racetrack Tubing)
Steel Thickness	: 2.75 - 2.5mm

IE 7007B

MULTI-HYPER EXT.

Product Code: 43014

Size (LxWxH)	: 1312 x 749 x 914 mm
Net Weight	: 43 Kgs.
Steel Tubing	: 100 x 50mm (Racetrack Tubing)
Steel Thickness	: 2.75 - 2.5mm





IE 7011C

MULTI-ADJ. BENCH

Product Code: 43016

Size (LxWxH)	: 1212 x 750 x 465 mm
Net Weight	: 40 Kgs.
Steel Tubing	: 100 x 50mm (Racetrack Tubing)
Steel Thickness	: 2.75 - 2.5mm

IE 7014B

FLAT BENCH PRESS

Product Code: 43017

Size (LxWxH)	: 1657 x 1658 x 1373 mm
Net Weight	: 82 Kgs.
Steel Tubing	: 100 x 50mm (Racetrack Tubing)
Steel Thickness	: 2.75 - 2.5mm



IE 7015C

INCLINE BENCH PRESS

Product Code: 43018

Size (LxWxH)	: 1632 x 1658 x 1373 mm
Net Weight	: 106 Kgs.
Steel Tubing	: 100 x 50mm (Racetrack Tubing)
Steel Thickness	: 2.75 - 2.5mm

IE 7017B

WEIGHT PLATE TREE

Product Code: 43019

Size (LxWxH)	: 950 x 610 x 1220 mm
Net Weight	: 26 Kgs.
Steel Tubing	: 100 x 50mm (Racetrack Tubing)
Steel Thickness	: 2.75 - 2.5mm



CTB SERIES

(DUAL) WEIGHT STATION



CTB 10

LAT PULL | ROW

Product Code: 44000

Size (LxWxH)	: 1790 x 1230 x 2320 mm
Net Weight	: 234 Kgs.
Weight Plates	: 100 Kgs.
Pulley	: 6.0 mm
Steel Tubing	: 50 x 100 mm
Steel Thickness	: 2.5 mm
Seat	: High Density PU
Weight Material	: Cast Iron
Cable	: 6 mm Dia.

CTB 12

MULTI PRESS

Product Code: 44001

Size (LxWxH)	: 1890 x 1470 x 1640 mm
Net Weight	: 224 Kgs.
Weight Plates	: 100 Kgs.
Pulley	: 6.0 mm
Steel Tubing	: 50 x 100 mm
Steel Thickness	: 2.5 mm
Seat	: High Density PU
Weight Material	: Cast Iron
Cable	: 6 mm Dia.



CTB 14

AB | BACK

Product Code: 44002

Size (LxWxH)	: 1290 x 1010 x 1620 mm
Net Weight	: 222 Kgs.
Weight Plates	: 100 Kgs.
Pulley	: 6.0 mm
Steel Tubing	: 50 x 100 mm
Steel Thickness	: 2.5 mm
Seat	: High Density PU
Weight Material	: Cast Iron
Cable	: 6 mm Dia.



CTB 25

SEATED LEG CURL | EXTENSION

Product Code: 44005

Size (LxWxH)	: 1500 x 650 x 1625 mm
Net Weight	: 222 Kgs.
Weight Plates	: 100 Kgs.
Pulley	: 6.0 mm
Steel Tubing	: 50 x 100 mm
Steel Thickness	: 2.5 mm
Seat	: High Density PU
Weight Material	: Cast Iron
Cable	: 6 mm Dia.





CTB 29

BICEP | TRICEP

Product Code: 44006

Size (LxWxH)	: 1190 x 950 x 1630 mm
Net Weight	: 222 Kgs.
Weight Plates	: 80 Kgs.
Pulley	: 6.0 mm
Steel Tubing	: 50 x 100 mm
Steel Thickness	: 2.5 mm
Seat	: High Density PU
Weight Material	: Cast Iron
Cable	: 6 mm Dia.

CTB-52

ABDUCTOR | ADDUCTOR

Product Code: 44007

Size (LxWxH)	: 1550 x 880 x 1620 mm
Net Weight	: 216 Kgs.
Weight Stack	: 100 Kgs.
Pulley	: 6.0 mm
Steel Tubing	: 50 x 100 mm
Steel Thickness	: 2.5 mm
Seat	: High Density PU
Weight Material	: Cast Iron
Cable	: 6 mm Dia.



CTB-91

HORIZONTAL | SEATED LEG CURL

Product Code: 44009

Size (LxWxH)	: 1700 x 930 x 1620 mm
Net Wt.	: 220 Kgs.
Weight Stack	: 100 Kgs.
Pulley	: 6.0 mm
Steel Tubing	: 50 x 100 mm
Steel Thickness	: 2.5 mm
Seat	: High Density PU
Weight Material	: Cast Iron
Cable	: 6 mm Dia.



CTB 59

LEG PRESS | HACK SQUAT

Product Code: 44008

Size (LxWxH)	: 2420 x 1610 x 1450 mm
Net Weight	: 249 Kgs.
Steel Tubing	: 50 x 100 mm
Steel Thickness	: 2.5 mm
Seat	: High Density PU
Weight Material	: Cast Iron



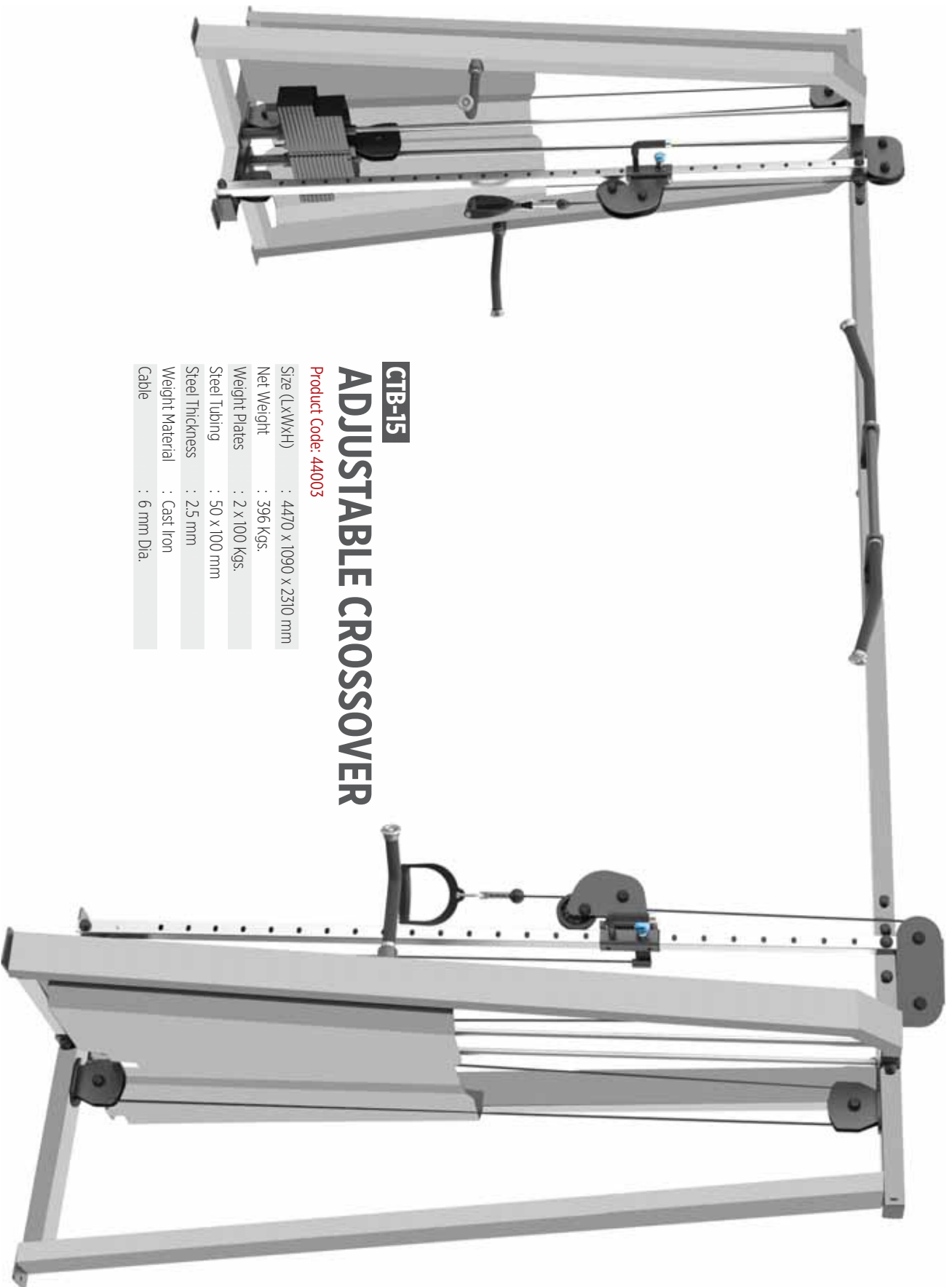

CTB-15

ADJUSTABLE CROSSOVER

Product Code: 44003

Size (LxWxH)	: 4470 x 1090 x 2310 mm
Net Weight	: 396 Kgs.
Weight Plates	: 2 x 100 Kgs.
Steel Tubing	: 50 x 100 mm
Steel Thickness	: 2.5 mm
Weight Material	: Cast Iron
Cable	: 6 mm Dia.



CTB-17

FUNCTIONAL TRAINER

Product Code: 44004

Size (LxWxH)	: 1050 x 1760 x 2250 mm
Net Weight	: 345 Kgs.
Weight Plates	: 2 x 100 Kgs.
Steel Tubing	: 50 x 100 mm
Steel Thickness	: 2.5 mm
Weight Material	: Cast Iron
Cable	: 6 mm Dia.



CTB-36 FLAT BENCH

Product Code: 44010

Size (LxWxH)	: 1420 x 570 x 430 mm
Net Weight	: 36 Kgs.
Steel Tubing	: 50 x 100mm
Steel Thickness	: 2.5mm

CTB-37 ADJUSTABLE DECLINE BENCH

Product Code: 44011

Size (LxWxH)	: 1660 x 670 x 770 mm
Net Weight	: 48 Kgs.
Steel Tubing	: 50 x 100mm
Steel Thickness	: 2.5mm



CTB-38 MULTI PURPOSE BENCH

Product Code: 44012

Size (LxWxH)	: 1200 x 670 x 820 mm
Net Weight	: 23 Kgs.
Steel Tubing	: 50 x 100mm
Steel Thickness	: 2.5mm

CTB-39 SUPER BENCH

Product Code: 44013

Size (LxWxH)	: 1400 x 670 x 440 mm
Net Weight	: 38 Kgs.
Steel Tubing	: 50 x 100mm
Steel Thickness	: 2.5mm





CTB-41

OLYMPIC DECLINE BENCH

Product Code: 44014

Size (LxWxH)	: 2060 x 1660 x 1220 mm
Net Weight	: 78 Kgs.
Steel Tubing	: 50 x 100mm
Steel Thickness	: 2.5mm

CTB-42

OLYMPIC INCLINE BENCH

Product Code: 44015

Size (LxWxH)	: 1980 x 1660 x 1400 mm
Net Weight	: 77 Kgs.
Steel Tubing	: 50 x 100mm
Steel Thickness	: 2.5mm



CTB-43

OLYMPIC FLAT BENCH

Product Code: 44016

Size (LxWxH)	: 1670 x 1660 x 1230 mm
Net Weight	: 61 Kgs.
Steel Tubing	: 50 x 100mm
Steel Thickness	: 2.5mm

Frame Colour : Silver | Seat Colour : Black



CTB-63

SMITH MACHINE

Product Code: 44025

Size (LxWxH) : 1450 x 2200 x 2200 mm

Net Weight : 284 Kgs.

Steel Tubing : 50 x 100mm

Steel Thickness : 2.5mm



CTB-48

POWER CAGE

Product Code: 44020

Size (LxWxH) : 1480 x 1330 x 2290 mm

Net Weight : 131 Kgs.

Steel Tubing : 50 x 100mm

Steel Thickness : 2.5mm

CTM-87

ADJUSTABLE BENCH (3 in 1)

Product Code: 44030

Size (LxWxH) : 1630 x 570 x 460 mm

Net Weight : 88 Kgs.



Frame Colour : Black | Seat Colour : Brown



CTB-47
**VERTICAL
 KNEES UP | DN**

Product Code: 44019

Size (LxWxH)	: 1170 x 750 x 1600 mm
Net Weight	: 69 Kgs.
Steel Tubing	: 50 x 100mm
Steel Thickness	: 2.5mm



CTB-65
SUPER SQUAT

Product Code: 44026

Size (LxWxH)	: 1990 x 1640 x 1450 mm
Net Weight	: 196 Kgs.
Steel Tubing	: 50 x 100mm
Steel Thickness	: 2.5mm



CTB-87
**SMITH WITH
 HACK SQUAT**

Product Code: 44029

Size (LxWxH)	: 2351 x 1367 x 2159 mm
Net Weight	: 260 Kgs.
Weight Plates	: 128 Kgs.
Steel Tubing	: 50 x 100 mm
Steel Thickness	: 2.5 mm
Weight Material	: Cast Iron
Cable	: 6 mm Dia.

Frame Colour : Silver | Seat Colour : Black



Frame Colour : Black | Seat Colour : Brown

CTB-86

FLAT | INCLINE | DECLINE BENCH (3 in 1)

Product Code: 44028

Bench Size (LxWxH): 1040 x 1730 x 1390 mm

Stand Size (LxWxH): 1600 x 760 x 580 mm

Net Weight : 140 Kgs.

CTB-44

SEATED PREACHER CURL

Product Code: 44017

Size (LxWxH) : 1340 x 780 x 940 mm

Net Weight : 46 Kgs.

Steel Tubing : 50 x 100mm

Steel Thickness : 2.5mm



CTB-45

BACK EXTENSION

Product Code: 44018

Size (LxWxH) : 1130 x 900 x 750 mm

Net Weight : 45 Kgs.

Steel Tubing : 50 x 100mm

Steel Thickness : 2.5mm

CTB-61

INCLINE LEVEL ROW

Product Code: 44023

Size (LxWxH) : 1800 x 1000 x 1160 mm

Net Weight : 60 Kgs.

Steel Tubing : 50 x 100mm

Steel Thickness : 2.5mm



Frame Colour : Silver | Seat Colour : Black

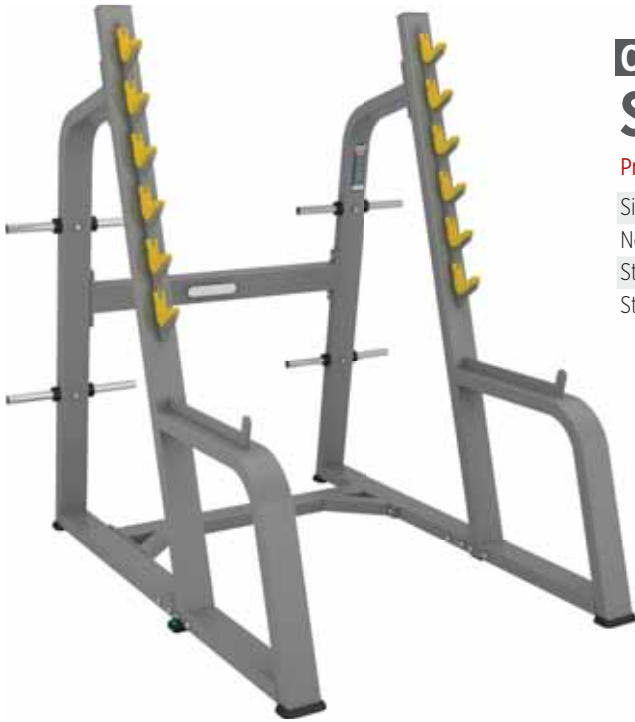

CTB-50
SQUAT RACK

Product Code: 44021

Size (LxWxH) : 1780 x 1680 x 1790 mm
 Net Weight : 111 Kgs.
 Steel Tubing : 50 x 100mm
 Steel Thickness : 2.5mm



CTB-54
PLATE TREE VERTICAL

Product Code: 44022

Size (LxWxH) : 600 x 600 x 1250 mm
 Net Weight : 40 Kgs.
 Steel Tubing : 50 x 100mm
 Steel Thickness : 2.5mm



CTB-62
SEATED CALF

Product Code: 44024

Size (LxWxH) : 1460 x 600 x 1015 mm
 Net Weight : 53 Kgs.
 Steel Tubing : 50 x 100mm
 Steel Thickness : 2.5mm

CTB-67
BEAUTY DUMBBELL
(3 TIER)

Product Code: 44027

Size (LxWxH) : 1445 x 650 x 1015 mm
 Net Weight : 69 Kgs.
 Steel Tubing : 50 x 100mm
 Steel Thickness : 2.5mm



Frame Colour : Silver | Seat Colour : Black



CSW SERIES

CSW15

WT. ASSISTED CHIN | DIP COMBO (IF8120)

Product Code: 44260

Size (LxWxH)	: 1460 x 1220 x 2130 mm
Net Weight	: 121 Kgs.
Weight Plates	: 170 lbs
Steel Tubing	: 51 x 76mm
Steel Thickness	: 2.5mm
Pulley	: Dia.114mm
Weight Material	: Cast Iron, Each Plate Wt. : 10 lbs





CSW7

LEG PRESS | CALF RAISE COMBO (IF8110)

Product Code: 44255

Size (LxWxH)	: 1540 x 1220 x 1700 mm
Net Weight	: 147 Kgs.
Weight Plates	: 200 lbs
Steel Tubing	: 51 x 76mm
Steel Thickness	: 2.5mm
Pulley	: Dia.114mm
Weight Material	: Cast Iron, Each Plate Wt. : 10 lbs

CSW5

LEG EXTENSION (IF8105)

Product Code: 44253

Size (LxWxH)	: 1190 x 1160 x 1400 mm
Net Weight	: 100 Kgs.
Weight Plates	: 170 lbs
Steel Tubing	: 51 x 76mm
Steel Thickness	: 2.5mm
Pulley	: Dia.114mm
Weight Material	: Cast Iron, Each Plate Wt. : 10 lbs





CSW6

LEG CURL (IF8106)

Product Code: 44254

Size (LxWxH)	: 1430 x 1170 x 1400 mm
Net Weight	: 103 Kgs.
Weight Plates	: 170 lbs
Steel Tubing	: 51 x 76mm
Steel Thickness	: 2.5mm
Pulley	: Dia.114mm
Weight Material	: Cast Iron, Each Plate Wt. : 10 lbs

CSW8

SHOULDER PRESS

(IF8112)

Product Code: 44256

Size (LxWxH)	: 1390 x 1190 x 1400 mm
Net Weight	: 87 Kgs.
Weight Plates	: 200 lbs
Steel Tubing	: 51 x 76mm
Steel Thickness	: 2.5mm
Pulley	: Dia.114mm
Weight Material	: Cast Iron, Each Plate Wt. : 10 lbs





CSW12

MUTLI PRESS COMBO

(IF8121)

Product Code: 44258

Size (LxWxH)	: 1810 x 1330 x 1400 mm
Net Weight	: 110 Kgs.
Weight Plates	: 200 lbs
Steel Tubing	: 51 x 76mm
Steel Thickness	: 2.5mm
Pulley	: Dia.114mm
Weight Material	: Cast Iron, Each Plate Wt. : 10 lbs

CSW13

BICEP | TRICEP COMBO

(IF8123)

Product Code: 44259

Size (LxWxH)	: 1260 x 840 x 2110 mm
Net Weight	: 76 Kgs.
Weight Plates	: 200 lbs
Steel Tubing	: 51 x 76mm
Steel Thickness	: 2.5mm
Pulley	: Dia.114mm
Weight Material	: Cast Iron, Each Plate Wt. : 10 lbs





CSW16

PEC DEC | REAR DELT (IF8122)

Product Code: 44261

Size (LxWxH)	: 1310 x 1450 x 1810 mm
Net Weight	: 100 Kgs.
Weight Stack	: 19+1cs/170 lbs
Steel Tubing	: 51 x 76mm
Steel Thickness	: 2.5mm
Pulley	: Dia.114mm
Weight Material	: Cast Iron, Each Plate Wt. : 10 lbs

CSW17

AB | BACK COMBO (IF8124)

Product Code: 44262

Size (LxWxH)	: 1210 x 1050 x 1400 mm
Net Weight	: 79 Kgs.
Weight Stack	: 19+1 cs/ 200 lbs
Steel Tubing	: 51 x 76mm
Steel Thickness	: 2.5mm
Pulley	: Dia.114mm
Weight Material	: Cast Iron, Each Plate Wt. : 10 lbs





CSW18

FUNCTIONAL TRAINER

(IFFT)

Product Code: 44263

Size (LxWxH)	: 900 x 1800 x 2130 mm
Net Weight	: 332 Kgs.
Weight Plates	: 2 x 91 Kgs./ 200 lbs
Steel Tubing	: 51 x 76mm
Steel Thickness	: 2.5mm
Pulley	: Dia.114mm
Weight Material	: Cast Iron, Each Plate Wt. : 10 lbs

CS SERIES

CS1

FLAT BENCH (IFFB)

Product Code: 44273

Size (LxWxH) : 1300 x 520 x 490 mm

Net Weight : 20 Kgs.

Steel Tubing : 51 x 76mm

Steel Thickness : 2.5mm



CS2

HYPER EXTENSION BENCH (IF45)

Product Code: 44274

Size (LxWxH) : 1300 x 520 x 490 mm

Net Weight : 20 Kgs.

Steel Tubing : 51 x 76mm

Steel Thickness : 2.5mm



CS3

MULTI-PURPOSE BENCH (IFFID)

Product Code: 44275

Size (LxWxH) : 1580 x 650 x 510 mm

Net Weight : 33 Kgs.

Steel Tubing : 51 x 76mm

Steel Thickness : 2.5mm



CS4

OLYMPIC FLAT BENCH PRESS (IFOFB)

Product Code: 44277

Size (LxWxH)	: 1520 x 1310 x 1260 mm
Net Weight	: 60 Kgs.
Steel Tubing	: 51 x 76mm
Steel Thickness	: 2.5mm



CS5

OLYMPIC INCLINE BENCH PRESS (IFOIB)

Product Code: 44278

Size (LxWxH):	1560 x 1310 x 1190 mm
Net Weight	: 68 Kgs.
Steel Tubing	: 51 x 76mm
Steel Thickness	: 2.5mm

CS6

OLYMPIC DECLINE BENCH PRESS (IFODB)

Product Code: 44279

Size (LxWxH)	: 1900 x 1310 x 1150 mm
Net Weight	: 70 Kgs.
Steel Tubing	: 51 x 76mm
Steel Thickness	: 2.5mm





CS7

OLYMPIC BENCH (IFOB)

Product Code: 44265

Size (LxWxH) : 1430 x 1260 x 1460 mm

Net Weight : 62 Kgs.

Steel Tubing : 51 x 76mm

Steel Thickness : 2.5mm



CS8

SEATED ARM CURL (IFSPC)

Product Code: 44268

Size (LxWxH) : 1020 x 710 x 890 mm

Net Weight : 24 Kgs.

Steel Tubing : 51 x 76mm

Steel Thickness : 2.5mm



CS10

AB | BACK MACHINE (IFABM)

Product Code: 44269

Size (LxWxH) : 1520 x 1000 x 1060 mm

Net Weight : 38 Kgs.

Steel Tubing : 51 x 76mm

Steel Thickness : 2.5mm



CS11

LEG EXTENTION | CURL (IFLEGM)

(IFLEGM)

Product Code: 44270

Size (LxWxH) : 1210 x 1040 x 1040 mm

Net Weight : 51 Kgs.

Steel Tubing : 51 x 76mm

Steel Thickness : 2.5mm



CS16

ADJ.ABDOMINAL BENCH (IFAAB)

Product Code: 44266

Size (LxWxH) : 1680 x 560 x 1140 mm

Net Weight : 24 Kgs.

Steel Tubing : 51 x 76mm

Steel Thickness : 2.5mm

CS15

BEAUTY BELL RACK

(IFDB4+IFDB4A)

Product Code: 44280

Size (LxWxH) : 1370 x 470 x 860 mm

Net Weight : 47 Kgs.

Steel Tubing : 51 x 76mm

Steel Thickness : 2.5mm



CS18

TREE PLATE RACK

(IFPTO)

Product Code: 44281

Size (LxWxH) : 840 x 630 x 1100 mm

Net Weight : 19 Kgs.(Olympic)

Steel Tubing : 51 x 76mm

Steel Thickness : 2.5mm



CS13

SMITH MACHINE W | LINEAR BEARING

(IFHC+IFHCS)

Product Code: 44271

Size (LxWxH) : 1960 x 1720 x 2090 mm

Net Weight : 133 Kgs.

Steel Tubing : 51 x 76mm

Steel Thickness : 2.5mm



CS14

LEG PRESS | HACK SQUAT (IFLPHS)

Product Code: 44272

Size (LxWxH) : 2500 x 800 x 1500 mm

Net Weight : 145 Kgs.

Steel Tubing : 51 x 76mm

Steel Thickness : 2.5mm

FORCE SERIES



CAD001

SEATED CHEST PRESS

Product Code: 45000

• Multi angle handles • Adjustable seat pedals • Ergonomic movement.

Size (LxWxH) : 1500 x 960 x 1645 mm

Net Weight : 210 Kgs.

Steel Tubing : 70 x 130 mm (D Type)

Steel Tubing : 50 x 120 mm (Flat Oval)

Steel Thickness : 3.0mm

Frame Colour : Silver

Pulley : 105mm(Dia.)

Seat Colour | Material : Black | PU, once forming technology

Wt. Stack | Material : 100 Kgs. | Alloy Steel

CAD004

SEATED ROW

Product Code: 45003

• Multi angle handles • Adjustable seat pedals • Ergonomic movement.

Size (LxWxH) : 1420 x 1090 x 1645 mm

Net Weight : 222 Kgs.

Steel Tubing : 70 x 130 mm (D Type)

Steel Tubing : 50 x 120 mm (Flat Oval)

Steel Thickness : 3.0mm

Frame Colour : Silver

Pulley : 105mm(Dia.)

Seat Colour | Material : Black | PU, once forming technology

Wt. Stack | Material : 100 Kgs. | Alloy Steel



CAD008

CHIN DIP ASSIST

Product Code: 45005

• Multi-angle handle • Ultra quiet linear bearing.

Size (LxWxH) : 1520 x 955 x 2260 mm

Net Weight : 258 Kgs.

Steel Tubing : 70 x 130 mm (D Type)

Steel Tubing : 50 x 120 mm (Flat Oval)

Steel Thickness : 3.0mm

Frame Colour : Silver

Pulley : 105mm(Dia.)

Seat Colour | Material : Black | PU, once forming technology

Wt. Stack | Material : 100 Kgs. | Alloy Steel





CAD003

SHOULDER PRESS

Product Code: 45002

- Multi angle handles • Adjustable seat pedals • Ergonomic movement.

Size (LxWxH) : 1700 x 1500 x 1645 mm

Net Weight : 244 Kgs.

Steel Tubing : 70 x 130 mm (D Type)

Steel Tubing : 50 x120 mm (Flat Oval)

Steel Thickness : 3.0mm

Frame Colour : Silver

Pulley : 105mm(Dia.)

Seat Colour | Material : Black | PU, once forming technology

Wt. Stack | Material : 100 Kgs. | Alloy Steel

CAD006

BICEPS CURL MACHINE

Product Code: 45004

- Multi angle handles • Adjustable seat pedals • Ergonomic movement.

Size (LxWxH) : 1185 x 1230 x 1345 mm

Net Weight : 184 Kgs.

Steel Tubing : 70 x 130 mm (D Type)

Steel Tubing : 50 x120 mm (Flat Oval)

Steel Thickness : 3.0mm

Frame Colour : Silver

Pulley : 105mm(Dia.)

Seat Colour | Material : Black | PU, once forming technology

Wt. Stack | Material : 80 Kgs. | Alloy Steel





CAD002A

PEC FLY | REAR DELT

Product Code: 45001

- Multi angle handles • Adjustable seat pedals • Ergonomic movement.

Size (LxWxH) : 1265 x 1650 x 2020 mm

Net Weight : 218 Kgs.

Steel Tubing : 70 x 130 mm (D Type)

Steel Tubing : 50 x 120 mm (Flat Oval)

Steel Thickness : 3.0mm

Frame Colour : Silver

Pulley : 105mm(Dia.)

Seat Colour | Material : Black | PU, once forming technology

Wt. Stack | Material : 100 Kgs. | Alloy Steel

CAD014

LEG EXTENSION

Product Code: 45010

- Multi angle handles • Adjustable seat pedals • Ergonomic movement.

Size (LxWxH) : 1675 x 1210 x 1645 mm

Net Weight : 198 Kgs.

Steel Tubing : 70 x 130 mm (D Type)

Steel Tubing : 50 x 120 mm (Flat Oval)

Steel Thickness : 3.0mm

Frame Colour : Silver

Pulley : 105mm(Dia.)

Seat Colour | Material : Black | PU, once forming technology

Wt. Stack | Material : 80 Kgs. | Alloy Steel





CAD010

ABDOMINAL CRUNCH

Product Code: 45006

- Multi angle handles • Adjustable seat pedals • Ergonomic movement.

Size (LxWxH) : 1210 x 1155 x 1645 mm

Net Weight : 198 Kgs.

Steel Tubing : 70 x 130 mm (D Type)

Steel Tubing : 50 x 120 mm (Flat Oval)

Steel Thickness : 3.0mm

Frame Colour : Silver

Pulley : 105mm(Dia.)

Seat Colour | Material : Black | PU, once forming technology

Wt. Stack | Material : 80 Kgs. | Alloy Steel

CAD012A

SEATED HORIZONTAL PULLY

Product Code: 45007

- Multi-angle handle • Ultra quiet linear bearing.

Size (LxWxH) : 1570 x 1090 x 1645 mm

Net Weight : 194 Kgs.

Steel Tubing : 70 x 130 mm (D Type)

Steel Tubing : 50 x 120 mm (Flat Oval)

Steel Thickness : 3.0mm

Frame Colour : Silver

Pulley : 105mm(Dia.)

Seat Colour | Material : Black | PU, once forming technology

Wt. Stack | Material : 100 Kgs. | Alloy Steel





CAD013A

HORIZONTAL LEG CURL

Product Code: 45009

• Multi-angle handle • Ultra quiet linear bearing.

Size (LxWxH) : 1650 x 1145 x 1645 mm

Net Weight : 232 Kgs.

Steel Tubing : 70 x 130 mm (D Type)

Steel Tubing : 50 x 120 mm (Flat Oval)

Steel Thickness : 3.0mm

Frame Colour : Silver

Pulley : 105mm(Dia.)

Seat Colour | Material : Black | PU, once forming technology

Wt. Stack | Material : 100 Kgs. | Alloy Steel



CAD012B

LAT PULL DOWN

Product Code: 45008

• Multi angle handles • Adjustable seat pedals • Ergonomic movement.

Size (LxWxH) : 1225 x 1455 x 2300 mm

Net Weight : 188 Kgs.

Steel Tubing : 70 x 130 mm (D Type)

Steel Tubing : 50 x 120 mm (Flat Oval)

Steel Thickness : 3.0mm

Frame Colour : Silver

Pulley : 105mm(Dia.)

Seat Colour | Material : Black | PU, once forming technology

Wt. Stack | Material : 100 Kgs. | Alloy Steel



CAD018

INNER THIGH ADDUCTOR

Product Code: 45011

- Multi-angle handle • Ultra quiet linear bearing.

Size (LxWxH)	: 1365 x 1420 x 1645 mm
Net Weight	: 202 Kgs.
Steel Tubing	: 70 x 130 mm (D Type)
Steel Tubing	: 50 x120 mm (Flat Oval)
Steel Thickness	: 3.0mm
Frame Colour	: Silver
Pulley	: 105mm(Dia.)
Seat Colour Material	: Black PU, once forming technology
Wt. Stack Material	: 80 Kgs. Alloy Steel

CAD019

OUTER THIGH ABDUCTOR

Product Code: 45012

- Multi angle handles • Adjustable seat pedals • Ergonomic movement.

Size (LxWxH)	: 1355 x 1270 x 1645 mm
Net Weight	: 202 Kgs.
Steel Tubing	: 70 x 130 mm (D Type)
Steel Tubing	: 50 x120 mm (Flat Oval)
Steel Thickness	: 3.0mm
Frame Colour	: Silver
Pulley	: 105mm(Dia.)
Seat Colour Material	: Black PU, once forming technology
Wt. Stack Material	: 80 Kgs. Alloy Steel





CANON SERIES



CTG 05

CHEST PRESS

Product Code: 44800

Size (LxWxH)	: 1185 x 1660 x 1740mm
Net Weight	: 165 Kgs.
Steel Tubing	: 60 x 120mm
Round Pipe(dia.)	: 105mm
Steel Thickness	: 3.0mm
Frame Colour	: Black
Seat Material	: PU with once forming technology
Arms Colour	: Fluro Green

CTG 15

INCLINE CHEST PRESS

Product Code: 44801

Size (LxWxH)	: 1040 x 1890 x 1700mm
Net Weight	: 152 Kgs.
Steel Tubing	: 60 x 120mm
Round Pipe(dia.)	: 105mm
Steel Thickness	: 3.0mm
Frame Colour	: Black
Seat Material	: PU with once forming technology
Arms Colour	: Fluro Green





CTG 25

LOW ROW

Product Code: 44803

Size (LxWxH)	: 1310 x 1290 x 1660mm
Net Weight	: 167 Kgs.
Steel Tubing	: 60 x 120mm
Round Pipe(dia.)	: 105mm
Steel Thickness	: 3.0mm
Frame Colour	: Black
Seat Material	: PU with Once Forming Technology
Arms Colour	: Fluro Green

CTG 20

PULL DOWN

Product Code: 44802

Size (LxWxH)	: 1810 x 1160 x 1925mm
Net Weight	: 128 Kgs.
Steel Tubing	: 60 x 120mm
Round Pipe(dia.)	: 105mm
Steel Thickness	: 3.0mm
Frame Colour	: Black
Seat Material	: PU with Once Forming Technology
Arms Colour	: Fluro Green





CTG 30

INCLINE LEVEL ROW

Product Code: 44804

Size (LxWxH)	: 1440 x 1390 x 1300mm
Net Weight	: 148 Kgs.
Steel Tubing	: 60 x 120mm
Round Pipe(dia.)	: 105mm
Steel Thickness	: 3.0mm
Frame Colour	: Black
Seat Material	: PU with Once Forming Technology
Arms Colour	: Fluro Green

CTG 35

SHOULDER PRESS

Product Code: 44805

Size (LxWxH)	: 1275 x 1525 x 1520mm
Net Weight	: 135 Kgs.
Steel Tubing	: 60 x 120mm
Round Pipe(dia.)	: 105mm
Steel Thickness	: 3.0mm
Frame Colour	: Black
Seat Material	: PU with Once Forming Technology
Arms Colour	: Fluro Green





CTG 40

REAR KICK

Product Code: 44806

Size (LxWxH)	: 1490 x 1130 x 1610mm
Net Weight	: 120 Kgs.
Steel Tubing	: 60 x 120mm
Round Pipe(dia.)	: 105mm
Steel Thickness	: 3.0mm
Frame Colour	: Black
Seat Material	: PU with Once Forming Technology
Arms Colour	: Fluro Green



CTG 60

TRICEPS

Product Code: 44807

Size (LxWxH)	: 1700 x 1450 x 1030mm
Net Weight	: 175 Kgs.
Steel Tubing	: 60 x 120mm
Round Pipe(dia.)	: 105mm
Steel Thickness	: 3.0mm
Frame Colour	: Black
Seat Material	: PU with Once Forming Technology
Arms Colour	: Fluro Green



CTG 65

BICEPS

Product Code: 44808

Size (LxWxH)	: 1060 x 1630 x 950mm
Net Weight	: 160 Kgs.
Steel Tubing	: 60 x 120mm
Round Pipe(dia.)	: 105mm
Steel Thickness	: 3.0mm
Frame Colour	: Black
Seat Material	: PU with Once Forming Technology
Arms Colour	: Fluro Green

CTG 70

LEG EXTENSION

Product Code: 44809

Size (LxWxH)	: 1250 x 1345 x 1185mm
Net Weight	: 160 Kgs.
Steel Tubing	: 60 x 120mm
Round Pipe(dia.)	: 105mm
Steel Thickness	: 3.0mm
Frame Colour	: Black
Seat Material	: PU with Once Forming Technology
Arms Colour	: Fluro Green



NITRO SERIES

CE 5003

LEG PRESS

Product Code: 44517

Size (LxWxH)	: 1850 x 1050 x 1500 mm
Net Weight	: 255 Kgs.
Weight Plates	: 109 Kgs.
Steel Tubing	: 50 x 100 mm
Steel Thickness	: 2.5 mm
Seat	: High Density PU
Weight Material	: Cast Iron
Cable	: 6 mm Dia.



CE 5001

PRONE LEG CURL

Product Code: 44515

Size (LxWxH)	: 1800 x 970 x 1500 mm
Net Weight	: 205 Kgs.
Weight Plates	: 94 Kgs.
Steel Tubing	: 50 x 100 mm
Steel Thickness	: 2.5 mm
Seat	: High Density PU
Weight Material	: Cast Iron
Cable	: 6 mm Dia.



CE 5002

LEG EXTENSION

Product Code: 44516

Size (LxWxH)	: 1400 x 1050 x 1500 mm
Net Weight	: 214 Kgs.
Weight Plates	: 109 Kgs.
Steel Tubing	: 50 x 100 mm
Steel Thickness	: 2.5 mm
Seat	: High Density PU
Weight Material	: Cast Iron
Cable	: 6 mm Dia.





CE 5006

SHOULDER PRESS

Product Code: 44518

Size (LxWxH)	: 1900 x 1350 x 1500 mm
Net Weight	: 231 Kgs.
Weight Plates	: 109 Kgs.
Steel Tubing	: 50 x 100 mm
Steel Thickness	: 2.5 mm
Seat	: High Density PU
Weight Material	: Cast Iron
Cable	: 6 mm Dia.



CE 5007

PEC FLY | REAR DELT

Product Code: 44519

Size (LxWxH)	: 1240 x 940 x 2110 mm
Net Weight	: 227 Kgs.
Weight Plates	: 109 Kgs.
Steel Tubing	: 50 x 100 mm
Steel Thickness	: 2.5 mm
Seat	: High Density PU
Weight Material	: Cast Iron
Cable	: 6 mm Dia.



CE 5008

VERTICAL PRESS

Product Code: 44520

Size (LxWxH)	: 1400 x 1350 x 1500 mm
Net Weight	: 214 Kgs.
Weight Plates	: 109 Kgs.
Steel Tubing	: 50 x 100 mm
Steel Thickness	: 2.5 mm
Seat	: High Density PU
Weight Material	: Cast Iron
Cable	: 6 mm Dia.

CE 5009

DIP | CHIN ASSIST

Product Code: 44521

Size (LxWxH)	: 1550 x 1370 x 2360 mm
Net Weight	: 289 Kgs.
Weight Plates	: 88 Kgs.
Steel Tubing	: 50 x 100 mm
Steel Thickness	: 2.5 mm
Seat	: High Density PU
Weight Material	: Cast Iron
Cable	: 6 mm Dia.





CE 5023

SEATED LEG CURL

Product Code: 44522

Size (LxWxH)	: 1580 x 1050 x 1500 mm
Net Weight	: 220 Kgs.
Weight Plates	: 109 Kgs.
Steel Tubing	: 50 x 100 mm
Steel Thickness	: 2.5 mm
Seat	: High Density PU
Weight Material	: Cast Iron
Cable	: 6 mm Dia.

CE 5030

BICEP CURL

Product Code: 44523

Size (LxWxH)	: 1500 x 1300 x 1500 mm
Net Weight	: 194 Kgs.
Weight Plates	: 94 Kgs.
Steel Tubing	: 50 x 100 mm
Steel Thickness	: 2.5 mm
Seat	: High Density PU
Weight Material	: Cast Iron
Cable	: 6 mm Dia.





CE 5034

VERTICAL ROW

Product Code: 44524

Size (LxWxH)	: 1500 x 1300 x 1500 mm
Net Weight	: 194 Kgs.
Weight Plates	: 94 Kgs.
Steel Tubing	: 50 x 100 mm
Steel Thickness	: 2.5 mm
Seat	: High Density PU
Weight Material	: Cast Iron
Cable	: 6 mm Dia.



CE 5035

PULL DOWN

Product Code: 44525

Size (LxWxH)	: 1850 x 1090 x 2340 mm
Net Weight	: 248 Kgs.
Weight Plates	: 109 Kgs.
Steel Tubing	: 50 x 100 mm
Steel Thickness	: 2.5 mm
Seat	: High Density PU
Weight Material	: Cast Iron
Cable	: 6 mm Dia.

MAGNUM SERIES

CE 3003

LEG PRESS

Product Code: 44502

Size (LxWxH)	: 1900 x 1100 x 1620 mm
Net Weight	: 220 Kgs.
Weight Plates	: 109 Kgs.
Steel Tubing	: 50 x 100 mm
Steel Thickness	: 2.5 mm
Seat	: High Density PU
Weight Material	: Cast Iron
Cable	: 6 mm Dia.





CE 3001

PRONE LEG CURL

Product Code: 44500

Size (LxWxH)	: 1520 x 990 x 1620 mm
Net Weight	: 216 Kgs.
Weight Plates	: 94 Kgs.
Steel Tubing	: 50 x 100 mm
Steel Thickness	: 2.5 mm
Seat	: High Density PU
Weight Material	: Cast Iron
Cable	: 6 mm Dia.

CE 3002

LEG EXTENSION

Product Code: 44501

Size (LxWxH)	: 1300 x 990 x 1350 mm
Net Weight	: 223 Kgs.
Weight Plates	: 109 Kgs.
Steel Tubing	: 50 x 100 mm
Steel Thickness	: 2.5 mm
Seat	: High Density PU
Weight Material	: Cast Iron
Cable	: 6 mm Dia.





CE 3006

SHOULDER PRESS

Product Code: 44503

Size (LxWxH)	: 1850 x 1220 x 1320 mm
Net Weight	: 239 Kgs.
Weight Plates	: 109 Kgs.
Steel Tubing	: 50 x 100 mm
Steel Thickness	: 2.5 mm
Seat	: High Density PU
Weight Material	: Cast Iron
Cable	: 6 mm Dia.



CE 3007

PEC FLY | REAR DELT

Product Code: 44504

Size (LxWxH)	: 1240 x 990 x 2110 mm
Net Weight	: 227 Kgs.
Weight Plates	: 109 Kgs.
Steel Tubing	: 50 x 100 mm
Steel Thickness	: 2.5 mm
Seat	: High Density PU
Weight Material	: Cast Iron
Cable	: 6 mm Dia.

CE 3008

VERTICAL PRESS

Product Code: 44505

Size (LxWxH)	: 1320 x 1300 x 1350 mm
Net Weight	: 214 Kgs.
Weight Plates	: 109 Kgs.
Steel Tubing	: 50 x 100 mm
Steel Thickness	: 2.5 mm
Seat	: High Density PU
Weight Material	: Cast Iron
Cable	: 6 mm Dia.



CE 3009

DIP | CHIN ASSIST

Product Code: 44506

Size (LxWxH)	: 1550 x 1370 x 2360 mm
Net Weight	: 289 Kgs.
Weight Plates	: 88 Kgs.
Steel Tubing	: 50 x 100 mm
Steel Thickness	: 2.5 mm
Seat	: High Density PU
Weight Material	: Cast Iron
Cable	: 6 mm Dia.

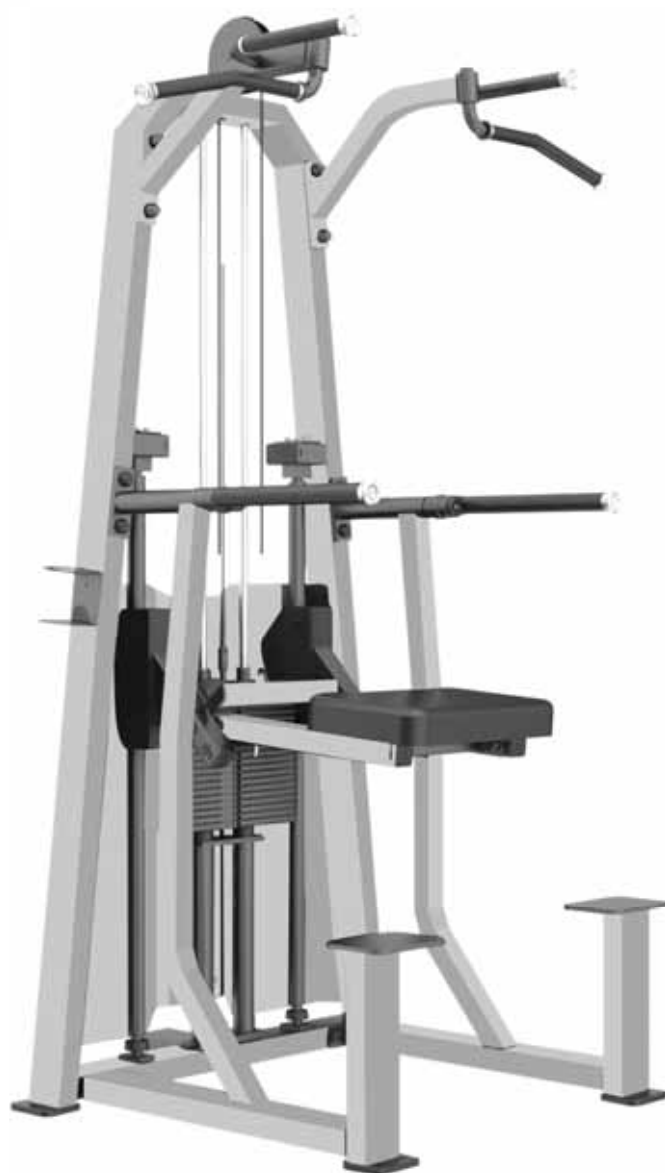

CE 3013

INCLINE PRESS

Product Code: 44507

Size (LxWxH)	: 2060 x 1350 x 1620 mm
Net Weight	: 215 Kgs.
Weight Plates	: 109 Kgs.
Steel Tubing	: 50 x 100 mm
Steel Thickness	: 2.5 mm
Seat	: High Density PU
Weight Material	: Cast Iron
Cable	: 6 mm Dia.





CE 3023

SEATED LEG CURL

Product Code: 44508

Size (LxWxH)	: 1650 x 940 x 1350 mm
Net Weight	: 220 Kgs.
Weight Plates	: 109 Kgs.
Steel Tubing	: 50 x 100 mm
Steel Thickness	: 2.5 mm
Seat	: High Density PU
Weight Material	: Cast Iron
Cable	: 6 mm Dia.



CE 3030

BICEPS | CAMBER CURL

Product Code: 44509

Size (LxWxH)	: 1190 x 890 x 1620 mm
Net Weight	: 158 Kgs.
Weight Plates	: 64 Kgs.
Steel Tubing	: 50 x 100 mm
Steel Thickness	: 2.5 mm
Seat	: High Density PU
Weight Material	: Cast Iron
Cable	: 6 mm Dia.



CE 3033

LONG PULL

Product Code: 44510

Size (LxWxH)	: 2820 x 1090 x 2360 mm
Net Weight	: 268 Kgs.
Weight Plates	: 109 Kgs.
Steel Tubing	: 50 x 100 mm
Steel Thickness	: 2.5 mm
Seat	: High Density PU
Weight Material	: Cast Iron
Cable	: 6 mm Dia.



CE 3035

PULL DOWN

Product Code: 44511

Size (LxWxH)	: 1850 x 1090 x 2340 mm
Net Weight	: 248 Kgs.
Weight Plates	: 109 Kgs.
Steel Tubing	: 50 x 100 mm
Steel Thickness	: 2.5 mm
Seat	: High Density PU
Weight Material	: Cast Iron
Cable	: 6 mm Dia.





CE 3036

FLAT BENCH

Product Code: 44526

Size (LxWxH)	: 1410 x 680 x 420 mm
Net Weight	: 30 Kgs.
Steel Tubing	: 50 x 100mm
Steel Thickness	: 2.5mm

CE 3037

**ADJUSTABLE
DECLINE BECH**

Product Code: 44527

Size (LxWxH)	: 1640 x 680 x 990 mm
Net Weight	: 59 Kgs.
Steel Tubing	: 50 x 100mm
Steel Thickness	: 2.5mm



CE 3039

SUPER BENCH

Product Code: 44529

Size (LxWxH)	: 1380 x 680 x 690 mm
Net Weight	: 43 Kgs.
Steel Tubing	: 50 x 100mm
Steel Thickness	: 2.5mm

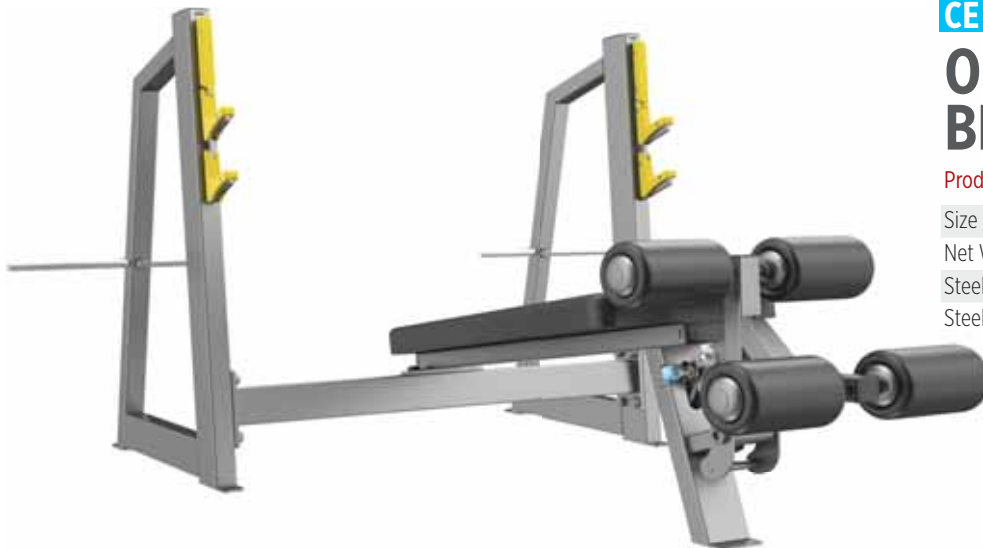

CE 3041

OLYMPIC DECLINE BENCH

Product Code: 44530

Size (LxWxH)	: 2090 x 1700 x 1220 mm
Net Weight	: 98 Kgs.
Steel Tubing	: 50 x 100 mm
Steel Thickness	: 2.5mm

CE 3042

OLYMPIC INCLINE BENCH

Product Code: 44531

Size (LxWxH)	: 1960 x 1700 x 1400 mm
Net Weight	: 127 Kgs.
Steel Tubing	: 50 x 100 mm
Steel Thickness	: 2.5mm



CE 3043

OLYMPIC FLAT BENCH

Product Code: 44532

Size (LxWxH)	: 1740 x 1700 x 1220 mm
Net Weight	: 94 Kgs.
Steel Tubing	: 50 x 100 mm
Steel Thickness	: 2.5mm



CE 3056

ANGLED LEG PRESS

Product Code: 44539

Size (LxWxH) : 2210 x 1630 x 1350 mm

Net Weight : 266 Kgs.

Steel Tubing : 50 x 100 mm

Steel Thickness : 2.5mm



CE 3057

HACK SQUAT

Product Code: 44540

Size (LxWxH) : 2240x1260x1260 mm

Net Weight : 196 Kgs.

Steel Tubing : 50 x 100 mm

Steel Thickness : 2.5mm





CE 3065

SUPER SQUAT

Product Code: 44544

Size (LxWxH)	: 2010 x 1630 x 1470 mm
Net Weight	: 196 Kgs.
Steel Tubing	: 50 x 100 mm
Steel Thickness	: 2.5mm

CE 3062

SEATED CALF

Product Code: 44542

Size (LxWxH)	: 1500x710x990 mm
Net Weight	: 75 Kgs.
Steel Tubing	: 50 x 100 mm
Steel Thickness	: 2.5mm





CE 3063

SMITH MACHINE

Product Code: 44543

Size (LxWxH) : 1420 x 2210 x 2360 mm

Net Weight : 289 Kgs.

Steel Tubing : 50 x 100 mm

Steel Thickness : 2.5mm



CE 3048

POWER CAGE

Product Code: 44536

Size (LxWxH) : 1570 x 1240 x 2340 mm

Net Weight : 164 Kgs.

Steel Tubing : 50 x 100 mm

Steel Thickness : 2.5mm



CE 6221

HALF RACK

Product Code: 44546

Size (LxWxH)	: 1735x1800x2465 mm
Net Weight	: 255 Kgs.
Steel Tubing	: 50 x 100 mm
Steel Thickness	: 2.5mm

CE 3050

SQUAT RACK

Product Code: 44537

Size (LxWxH)	: 1730 x 1700 x 1780 mm
Net Weight	: 160 Kgs.
Steel Tubing	: 50 x 100mm
Steel Thickness	: 2.5mm





CE 3047

VERTICAL KNEES UP | DIP

Product Code: 44535

Size (LxWxH)	: 12700 x 710 x 1600 mm
Net Weight	: 100 Kgs.
Steel Tubing	: 50 x 100mm
Steel Thickness	: 2.5mm

CE 3038

MULTI-PURPOSE BENCH

Product Code: 44528

Size (LxWxH)	: 1060 x 680 x 900 mm
Net Weight	: 35 Kgs.
Steel Tubing	: 50 x 100mm
Steel Thickness	: 2.5mm



CE 3061

INCLINE LEVEL ROW

Product Code: 44541

Size (LxWxH)	: 1850 x 790 x 1190 mm
Net Weight	: 90 Kgs.
Steel Tubing	: 50 x 100mm
Steel Thickness	: 2.5mm



CE 3044

SEATED PREACHER CURL

Product Code: 44533

Size (LxWxH)	: 1130 x 840 x 880 mm
Net Weight	: 54 Kgs.
Steel Tubing	: 50 x 100 mm
Steel Thickness	: 2.5mm

CE 3045

BACK EXTENSION

Product Code: 44534

Size (LxWxH)	: 1210 x 890 x 670 mm
Net Weight	: 55 Kgs.
Steel Tubing	: 50 x 100 mm
Steel Thickness	: 2.5mm



CE 3054

VERTICAL PLATE TREE

Product Code: 44538

Size (LxWxH)	: 610 x 580 x 1240 mm
Net Weight	: 40 Kgs.
Steel Tubing	: 50 x 100 mm
Steel Thickness	: 2.5mm

CE 3077

DUMBBELL RACK (2 TIER)

Product Code: 44545

Size (LxWxH)	: 720 x 2480 x 810 mm
Net Weight	: 26 Kgs.
Steel Tubing	: 50 x 100 mm
Steel Thickness	: 2.5mm





CE 1801

TRANSFORM XT

DUAL CABLE CROSS

Product Code: 44514

Size(LxWxH) Minimum	: 1840 x 1080 x 1870 mm
Size(LxWxH) Maximum	: 1380 x 1600 x 2410 mm
Net Weight	: 350 Kgs.
Weight Plates	: 2 x 68 Kgs.
Steel Tubing	: 50 x 100 mm
Steel Thickness	: 2.5 mm
Weight Material	: Cast Iron
Cable	: 6 mm Dia.

Enhances strength of various muscle groups due to the versatile movements of its arms vertically and horizontally. It can follow almost any working movement. Pulleys are smooth and robust. Cables used are from USA. An open design makes it for all fitness levels. Handles moves independently.

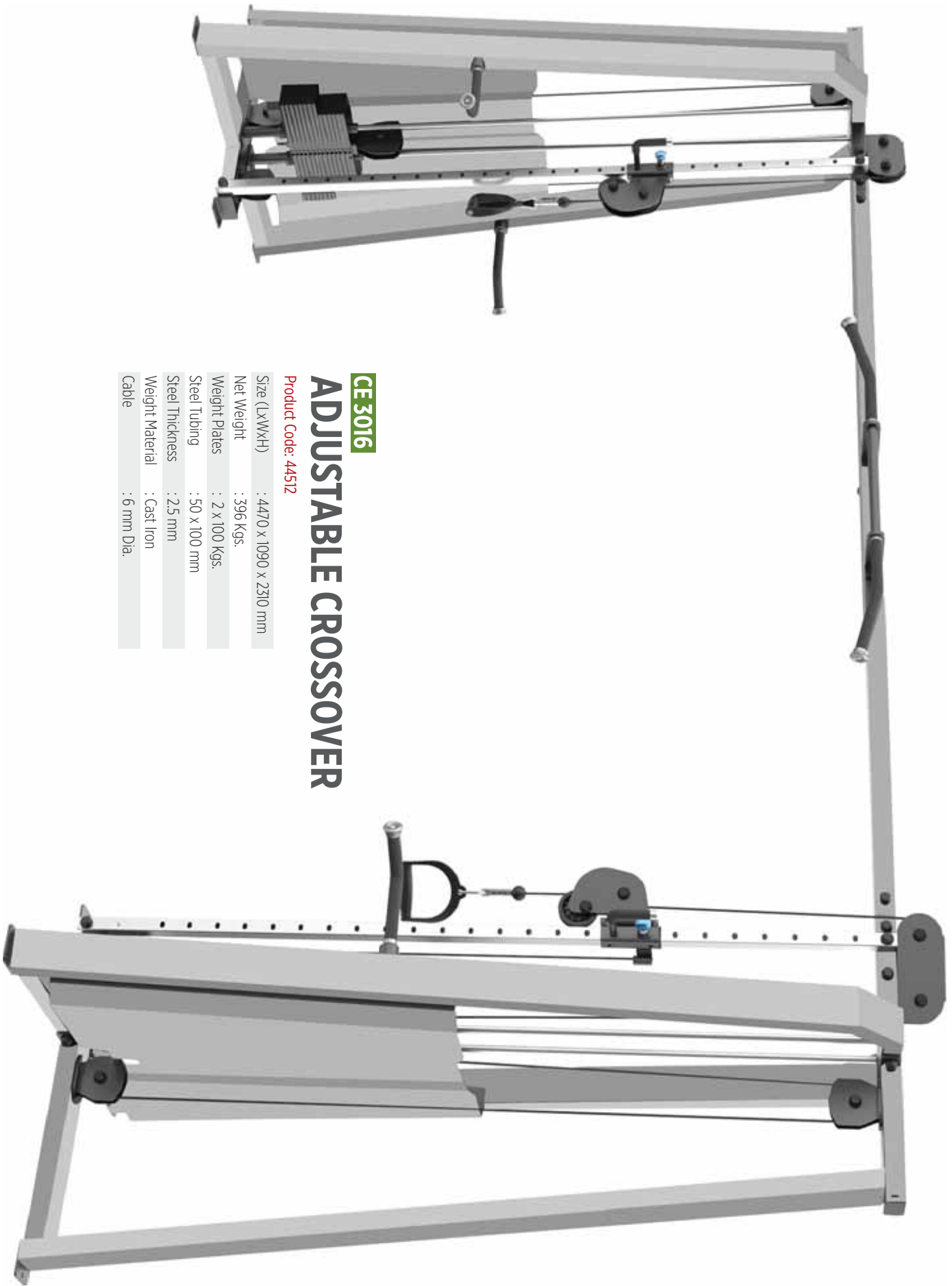

CE3016

ADJUSTABLE CROSSOVER

Product Code: 44512

Size (LxWxH)	: 4470 x 1090 x 2310 mm
Net Weight	: 396 Kgs.
Weight Plates	: 2 x 100 Kgs.
Steel Tubing	: 50 x 100 mm
Steel Thickness	: 2.5 mm
Weight Material	: Cast Iron
Cable	: 6 mm Dia.



CE 1017

FUNCTIONAL TRAINER

Product Code: 44513

Size (LxWxH)	: 1050 x 1760 x 2250 mm
Net Weight	: 345 Kgs.
Weight Plates	: 2 x 100 Kgs.
Steel Tubing	: 50 x 100 mm
Steel Thickness	: 2.5 mm
Weight Material	: Cast Iron
Cable	: 6 mm Dia.



CG-600

SIX STATION GYM

Product Code: 44751

- Two Sets 70 Kgs **Steel Weight Stack**
- Dural Powder Coating Finish
- Pivot point on leg developer correctly align with knee joint for biomechanics
- 8mm Commercial Grade aircraft cables
- 104mm Pulley with commercial grade bearing
- 65mmx65mmx2.5mm and 60mmx60mmx2.0mm heavy duty construction tube
- Contoured ,deep padded seat and backrest

Max. User Weight : 150 Kgs.

Net Weight : 356 Kgs.

Assembly (LxWxH) : 3320 x 2440 x 2300mm

Function : Tricep Extension. Abdominal Crunch. Leg Extension & Leg Press, High Pull AB Crunch. Tricep Push-Down. Lat Pull Down, Bicep Curl. Pectoral Fly. Seated Press Bar Row, Preacher Curl, Bench Press, Leg Kick Back, Seated Shoulder Press , Dip ARM, Upright Row Standing Leg Curl, Standing Shoulder Knee, Raise & Dip Arm, Chin up, Sit up Dumbell Exercise, Lat Pull Bar And Ankle Strap , Power Tower.



CG-125

FIVE STATION GYM

Product Code: 44752

- Two Suit 145LBS Dead Weight Stacks filled **concrete vinyl plates**.
- Dual Powder Coating Finish
- Pivot point on leg developer correctly align with knee joint for biomechanics
- 2000lbs tensile strength aircraft cables
- 70x50mm heavy duty construction tube
- Contoured ,deep padded seat and backrest

Max. User Weight : 150 Kgs.

Net Weight : 270 Kgs.

Assembly (LxWxH) : 3140 x 2440 x 2300 mm

Functions : Tricep Extension Abdominal Crunch Leg Extension & Leg Press, High Pull, AB Crunch, Tricep Push-Down, Lat Pull Down, Bicep Curl, Pectoral Fly, Seated Press Bar Row, Preacher Curl Bench Press, Leg Kick Back, Seated Shoulder Press , Dip ARM Upright Row Standing Leg Curl, Standing Shoulder Knee Raise & Dip Arm Chin up, Sit up Dumbell Exercise with Lat Pull Bar And Ankle Strap , Power Tower.

CHG 405**FOUR STATION GYM**

Product Code: 44753

4 Station Gym with 4 Weight Stack at Total 600 lbs.

No Cable Change.

Workouts :Abdominal, Lat PullDown, Leg Press, Shoulder Press, Pec Dec, low Row, Bicep, Tricep, Leg curl, Low row

Weight Stack : 4 Wt.Stack of 150 lbs Each

Max. User Weight : 140 Kgs.

Net Weight : 416 Kgs.

Assembly (LxWxH) : 2100 x 2500 x 2200 mm

Functions : Abdominal, Lat PullDown, Leg Press, Shoulder Press, Pec Dec, low Row, Bicep, Tricep, Leg curl, Low row

**CHG 402****FOUR STATION GYM**

Product Code: 44754

4 Station Gym with 2 Weight Stack at Total 300 lbs.

No Cable Change.

Workouts : Abdominal, Lat PullDown, Leg Press, Shoulder Press, Pec Dec, Low Row, Bicep, Tricep, Push up, Vertical Knee Raise

Weight Stack : 2 Wt.Stack of 150 lbs Each

Max. User Weight : 135 Kgs.

Net Weight : 270 Kgs.

Assembly (LxWxH) : 2500 X 2500 X 2200 mm

Functions : Abdominal, Lat PullDown, Leg Press, Shoulder Press, Pec Dec, low Row, Bicep, Tricep, Push up, Vertical Knee Raise



CROSSFIT-CC 360XL - 8 GATES

Product Code: 44755



CROSSFIT-CC 360XS - 4 GATES

Product Code: 44756



CROSSFIT-CC 360XL

360A crossfit is designed with experienced imagination, best way of combination to variable exercise programs in limited space. You could work out in thousand different way on this machine

❖ Parallel bars

Wide grip, narrow grip, and support height adjustment. Complete all kinds of training action of parallel bar, with high degree of freedom.

❖ Chin-up

Chin-up trainer is a classical use for space. With high strength grinding treatment, stable, reliable and comfortable. Wide grip, narrow grip, horizontal, vertical, to meet all the needs of posture.

❖ Power Rope

Power rope training is a necessary course in advanced physical training. It adopts different ways of shaking to make effective exercise. It is helpful to improve the speed, strength and explosive force.

❖ Functional Trainer

Functional Trainer is one of the essential machine in the gym. Using different parts can exercise different muscles, with abundant training methods. It can nearly exercise all parts of the muscle.

❖ Hanging Rope

Hanging rope is originally from U.S. Navy Seals. With the help of user's own weight to do hundreds of training movement. It can increase strength, balance force, flexibility and core stability.

❖ Sandbag

Punching a sandbag is a necessary method for exercising neck and back muscle. Boxing sport has an especial health care effect on such people working at their desks.

❖ Medicine Ball

Medicine ball training is suitable for all ages of users, with a variety of methods. Medicine ball can fully exercise the chest, abdomen, back muscles. It can improve the user's explosive force and coordination .

❖ Elastic rope

Elastic rope is aimed at the user's small muscle group. With a variety of using methods, effectively preventing muscle strain.

❖ Knee raise training

It can specially exercise the waist and abdomen. It can replace the parallel bars to exercise the arm muscle.

❖ The springboard trainer

It is for the leg training to improve the user's strength and coordination. It can adjust the height of springboard, for different training intensity.

CROSSFIT-CC 360XL

Gates	: 8
Olympic Bar	: 1
Medicine ball	: 1kg, 2kg, 3kg, 4kg, 5kg
Kettle bell	: 4kg, 6kg, 8kg, 10kg
Sand bag	: 30kg (dia. 33cm, height 1.4m)
Physical Training Rope	: Length 9m, diameter 38mm
Steel Tubing	: 120 x 60 mm
Steel Thickness	: 3.0 mm
Training Rope	: 4 pieces in set
Net Weight	: 1760 Kgs.
Assembly (LxWxH)	: 5559 x 4415 x 2578 mm

CROSSFIT-CC 360XS

Gates	: 4
Kettle bell	: 4kg, 6kg, 8kg, 10kg
Dynamic rope	: Light, Medium, Heavy (13mm, 32mm, 64mm)
Physical Training Rope	: Length 9m, diameter 38mm
Steel Tubing	: 50 x 100 mm
Steel Thickness	: 3.0 mm
Training Rope	: 2 pieces
Net Weight	: 650 Kgs.
Assembly (LxWxH)	: 3053 x 3094 x 2422 mm

4 STATION GYM (INDIAN)

Max. User Weight : 150 kgs.

Available :-

- 16 Station Unit
- 12 Station Unit
- 10 Station Unit
- 8 Station Unit
- 6 Station Unit
- 5 Station Unit
- 4 Station Unit



SINGLE STATIONS- WEIGHT & NON WEIGHT (refer Page 99)

Popular Model	Club Model	Executive Model
<ol style="list-style-type: none"> 1. Frames are fabricated in 48 mm x 48 mm x 12 GZ Steel Tubes (2"x2") 2. Weight plates are of M.S. with Top Nickel Chrome plated & other Powder coated 3. Cable - 6 mm (Dia.) 4. Pulley - Double ball bearing 5. Handles & Rods - made from 25 mm M. S. Bright Nickel Chrome plated 6. Seat - Tear resistant Leatherite (Pro feel 25 mm) 7. Powder Coating for frames 	<p>Frames and Station are fabricated in (72 mm x 37 mm x 12 GZ) Steel Tubes. (3"x1.5")</p> <p>* Other features same as Popular Model</p>	<ol style="list-style-type: none"> 1. Frames and Station are fabricated in (92 mm x 46 mm x 12 GZ) Steel Tubes. (4"x2") 2. High Density Foam. 3. Double Cover Seat. 4. Leather Foam Seat Covering. <p>* Other features same as Popular Model</p>

SPECIFICATION - Multi Station GYM (Indian)

Available in Popular - Club- Executive Model

Frame- **A. Popular Model:** 48mmx48mmx12 GZ Steel | **B. Club Model:** 72mmx37mmx12 GZ Steel | Tubes Tubes | **C. Executive Model:** 92mmx46mmx12 GZ Steel Tubes
 (2"x2") (3"x1.5") (4"x2")

<h3>16 Station</h3> <ol style="list-style-type: none"> 1. Leg Press 110Kgs. 2. Peck Deck/Butter Fly 60 Kgs. 3. Bench Cum Shoulder Press 100 Kgs. 4. High Lat Pulley 75 Kgs. 5. Seated Rowing (Ground Pulley) 75 Kgs. 6. Leg Extension/Leg Curl 60 Kgs. 7. Preacher Curl (Arm Curl) 50 Kgs. 8. Wrist Conditioner 40 Kgs. 9. Squat Press 120 Kgs. 10. Chinning Bar 11. Hip Flexor 12. Abdominal Board 13. Hyper Extension (Back Extension) 14. Roman Chair 15. Dipping 16. Twister <p>Recommended Room Size: 20'x16'x9'</p>	<h3>12 Station</h3> <ol style="list-style-type: none"> 1. Leg Press 110 Kgs. 2. Peck Deck/Butter Fly 60 Kgs. 3. Bench Cum Shoulder Press 100 Kgs. 4. High Lat Pulley 75 Kgs. 5. Seated Rowing (Ground Pulley) 75 Kgs. 6. Leg Extension/Leg Curl 60 Kgs. 7. Preacher Curl (Arm Curl) 60 Kgs. 8. Chinning Bar/60 Kgs. 9. Hip Flexor 10. Abdominal Board 11. Hyper Extension (Back Extension) 12. Twister <p>Recommended Room Size: 18'x15'x9'</p>	<h3>10 Station</h3> <ol style="list-style-type: none"> 1. Bench cum Shoulder Press 100 Kgs. 2. Peck Deck/Butter Fly 60 Kgs. 3. High Lat Pulley 75 Kgs. 4. Seated Rowing (Ground Pulley) 75 Kgs. 5. Leg Extension/Leg Curl 60 Kgs. 6. Preacher Curl (Arm Curl) 50 Kgs. 7. Chinning Bar 8. Abdominal Board 9. Dipping 10. Twister <p>Recommended Room Size: 16'x14'x9'</p>	<h3>8 Station</h3> <ol style="list-style-type: none"> 1. Bench cum Shoulder Press 100 Kgs. 2. Peck Deck/Butter Fly 60 Kgs. 3. High Lat Pulley 75 Kgs. 4. Seated Rowing (Ground Pulley) 75 Kgs. 5. Preacher Curl (Arm Curl) 50 Kgs. 6. Chinning Bar 7. Abdominal Board 8. Twister <p>Recommended Room Size: 14'x14'x9'</p>
<h3>4 Station</h3> <ol style="list-style-type: none"> 1. High Lat Pulley 75 Kg 2. Seated Rowing (Ground Pulley) 75 Kgs. 3. Preacher Curl (Arm Curl) 50 Kgs. 4. Twister 	<h3>5 Station</h3> <ol style="list-style-type: none"> 1. Lat Pull Down, Leg Extension/Leg curl, Chest Press, Rowing 80 Kgs. 2. Peck Deck 60 Kgs. 3. Chinning Bar 4. Dipping with Hip Flexor 5. Twister <p>For Mini Clubs & Home Use</p>	<h3>6 Station</h3> <ol style="list-style-type: none"> 1. High Lat Pulley 75 Kgs. 2. Seated Rowing (Ground Pulley) 75 Kgs. 3. Leg Extension/Leg Curl 60 Kgs. 4. Preacher Curl (Arm Curl) 50 Kgs. 5. Abdominal Board 6. Twister <p>Recommended Room Size: 14'x12'x9'</p>	





AC 600

Product Code: 42113

AC 600 Treadmill is an excellent piece of fitness equipment with a great set of features to provide you with a varied and challenging workout. Heart rate sensor on crossbar handle. Foldable with Hydraulic Softdrop System.

Motor	: 1.5 HP (3 HP PEAK) AC Duty
Speed Range	: 0-16 Kmph
Incline	: 0-15%
Running Belt	: 19 x 54" (480 x 1370mm)
Display	: 7 inch Blue LCD display
Max. User Weight	: 130 Kgs.
Net Weight	: 84 Kgs.
Assembly (LxWxH)	: 1770 x 790 x 1360 mm
Foldable	: Yes
Emergency Stop	: Yes

ELECTRONICS

Functions	: USB with Speaker, Fan, Stable and New Design
Displays	: Speed, Distance, Time, Calorie, Incline, Heart Rate, Programs : 2 HR-2, Interval, Run, Fat Burn



AC Motor Emergency stop Motor Incline Fan USB Port



AC 450

Product Code: 42114

New Contemporary Design with Powerful AC Motor for Heavy Weight / Longer Duration use. Cushioning design on both sides of the treadmill to reduce noise and Shock Impact on your Ankles and Knees.

Motor	: 1.25 HP (2.5 HP PEAK) AC Duty
Speed Range	: 1.0-16 Kmph
Incline	: 0-16%
Running Belt	: 18 x 52" (460 x 1300mm)
Display	: 7" LCD
Max. User Weight	: 100 Kgs.
Net Weight	: 75 Kgs.
Assembly (LxWxH)	: 1702 x 777 x 1352 mm
Foldable	: Yes
Emergency Stop	: Yes

ELECTRONICS

Functions	: USB with Speaker, Fan, MP3, iPad Video Bracket
Displays	: Speed, Distance, Time, Calorie, Incline, Heart Rate, Programs



AC Motor Emergency stop Motor Incline Fan USB Port





DC Motor



Emergency stop



Motor Incline



Foldable



USB Port



K-55

Product Code: 42115

Sturdy, Reliable, made with High Grade Steel to ensure Durability. Cushioning design on both sides of the treadmill to reduce noise and Shock Impact on your Ankles and Knees. Optimised for workout at home. LCD screen allows you to monitor your progress in real-time.

Motor	: 2.5 HP (5 HP PEAK) DC Duty
Speed Range	: 1.0-18 Kmp
Incline	: Auto Incline 15%
Running Belt	: 20 x 52"(508x1320mm)
Display	: 1.7" LCD Display
Max. User Weight	: 130 Kgs.
Net Weight	: 84 Kgs.
Assembly (LxWxH)	: 1020 x 840 x 1585mm
Foldable	: Yes
Emergency Stop	: Yes

ELECTRONICS

Functions	: Mp3 and USB, 34 Programs : 1 Manual, 3 Target, 25 Preset, 5 User, 2 HRC
Displays	: Time, Speed, Distance, Pulse, Incline, Calories





K-44

Product Code: 42116

Optimised for workout at home. Double layer running board for better shock absorption to reduce stress on your joints. The pre-set program provides 20 set of pre-defined workouts that offers a variety of challenges for you. LCD screen allows you to monitor your progress in real-time.

Motor	: 2.0 HP (4 HP PEAK) DC Duty
Speed Range	: 1.0-16 Kmp
Incline	: Auto Incline 15%
Running Belt	: 18 x 52" (460x1320mm)
Display	: 1.7" LCD Display
Max. User Weight	: 120 Kgs.
Net Weight	: 71 Kgs.
Assembly (LxWxH)	: 1020 x 840 x 1585mm

ELECTRONICS

Functions	: Mp3 and USB, 25 Programs : 1 Manual, 3 Target, 20 Preset, 1 Body Fat, Emergency Stop, Foldable
Displays	: Speed, Time, Distance, Calorie, Pulse



K-33

Product Code: 42117

Equipped with Double layer running board for better shock absorption to reduce stress on your joints. The pre-set program provides 12 set of pre-defined workouts that offers a variety of challenges for you. LCD screen allows you to monitor your progress in real-time.

Motor	: 1.75 HP (3.5 HP PEAK) DC Duty
Speed Range	: 1.0-13 Kmp
Incline	: Auto Incline 15%
Running Belt	: 17 x 50" (420x1250mm)
Display	: 1.5" LCD Display
Max. User Weight	: 110 Kgs.
Net Weight	: 63 Kgs.
Assembly (LxWxH)	: 1700 x 735 x 1370mm

ELECTRONICS

Functions	: Mp3 and USB, 19 Programs : 1 Manual, 3 Target, 12 Preset, 3 User, Emergency Stop, Foldable
Displays	: Time, Speed, Distance, Pulse, Incline, Calories





K-22

Product Code: 42118

Ideal for all fitness levels. Double layer running board for better shock absorption to reduce stress on your joints. The pre-set program provides 12 set of pre-defined workouts that offers a variety of challenges for you. LCD screen allows you to monitor your progress in real-time

Motor	: 1.75 HP (3.5 HP PEAK) DC Duty
Speed Range	: 1.0-13 Kmp
Incline	: 3 Level Manual Incline
Running Belt	: 17 x 50"(420x1250mm)
Display	: 1.5" LCD Display
Max. User Weight	: 100 Kgs.
Net Weight	: 50 Kgs.
Assembly (LxWxH)	: 1650 x 730 x 1360mm

ELECTRONICS

Functions	: Mp3 and USB, 17 Programs : 1 Manual, 3 Target, 12 Preset, 1 Body Fat, Emergency Stop, Foldable
Displays	: Speed, Distance, Time, Calories, Pulse, Body Fat



K-11

Product Code: 42119

Ideal for workout at home. 6 pre-set programs can be chosen freely Contact heart rate testing on handrail. Wheels for Easy Transportation. LCD screen allows you to monitor your progress in real-time

Motor	: 1.5 HP (3 HP PEAK) DC Duty
Speed Range	: 1.0-10 Kmp
Incline	: 3 Level Manual Incline
Running Belt	: 16 x 48"(400x1200mm)
Display	: 1.5" LCD Display
Max. User Weight	: 100 Kgs.
Net Weight	: 46 Kgs.
Assembly (LxWxH)	: 1600 x 720 x 1260mm

ELECTRONICS

Functions	: Mp3, 10 Programs : 6 Preset, 1 Manual, 3 Target Programs, Emergency Stop, Foldable
Displays	: Speed, Distance, Time, Calories, Pulse



CMTM-4120

Product Code: 42125

Neo Design and Elegant Appearance. 5 LED readouts with one touch keys for speed and Incline. Entry Level Treadmill with Optimum Power. Motorised Incline adds to the ease of Exercise

Motor	: 1.75 HP (3.5 HP PEAK) DC Duty
Speed Range	: 1.0-12 Kph.
Incline	: Motor Incline 0-15%
Running Belt	: 17 x 48" (420x1200mm)
Display	: 5 LED Readout
Max. User Weight	: 110 Kgs.
Net Weight	: 44 Kgs.
Assembly (LxWxH)	: 1540 x 730 x 1300mm

ELECTRONICS

Functions	: USB, Speaker, Emergency Stop, Foldable
Displays	: 5 led displays : time, speed, distance, calorie,pulse



CMTM-4110

Product Code: 42126

Neo Design and Elegant Appearance powered by 1.75 HP Motor and 5 LED readouts. It has USB & Speaker for workout with entertainment. Entry Level Treadmill with Optimum Power.

Motor	: 1.75 HP D (3.5 HP PEAK) C Duty
Speed Range	: 1.0-12 Kph.
Incline	: 3 Level Manual Incline
Running Belt	: 17 x 48" (420x1200mm)
Display	: 5 LED Readout
Max. User Weight	: 110 Kgs.
Net Weight	: 42 Kgs.
Assembly (LxWxH)	: 1540 x 730 x 1300mm

ELECTRONICS

Functions	: USB, Speaker, Emergency Stop, Foldable
Displays	: 5 led displays : time, speed, distance, calorie,pulse

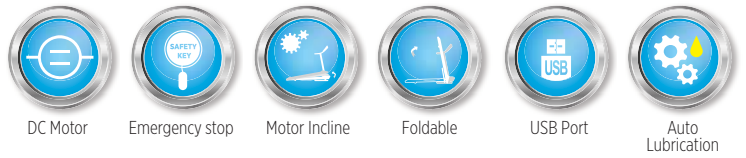

RUN 3.0

Product Code: 42144

Deluxe Treadmill with 2.0 HP DC Duty 4.0 HP Peak (Low Noise), Auto Lubrication System. Externally connected with Mp3, USB and internally installed with High-Fidelity Audio.



Motor	: 2.0 HP DC Duty (4.0 HP Peak) Low Noise
Speed Range	: 0.8-18 Kph.
Incline	: Auto Incline 0-18%
Running Belt	: 19 x 52"(485x1320mm)
Display	: LCD Blue Screen
Max. User Weight	: 130 Kgs.
Net Weight	: 84 Kgs.
Assembly (LxWxH)	: 1850 x 820 x 1370mm

ELECTRONICS

Functions	: Auto Lubrication, Mp3, USB, Hi-Fi Audio, Different Shock Absorption Effects. Programs P1-P109. Bluetooth for HK Treadmill Application only.
Displays	: Speed, Distance, Time, Calories, Pulse, Incline





RUN 2.0

Product Code: 42120

Deluxe Treadmill with 1.5 HP DC Motor, Six-level Shock Absorption and Semi-Auto Lubrication system. Externally connected with MP3,USB;and internally installed with High-Fidelity Audio.

Motor	: 1.5 HP DC Duty ((3 HP PEAK)
Speed Range	: 1.0-18 Kph.
Incline	: Auto Incline 18%
Running Belt	: 17 x 49"(450 x 1260mm) 1.8mm Thickness
Display	: LCD Display
Max. User Weight	: 120 Kgs.
Net Weight	: 68 Kgs.
Assembly (LxWxH)	: 1830 x 770 x 1370mm
Other Features	: 6 Level Shock Absorption, Semi-Auto Lubrication System

ELECTRONICS

Functions : Smart Memory Function, Run, Audio, HR, Bluetooth, Mp3, USB, Program : P1-P12 ,H1,H2,H3 Mode,FAT Mode.Bluetooth for HK Treadmill Application only.

Displays : Speed, Distance, Time, Calories, Pulse, Incline

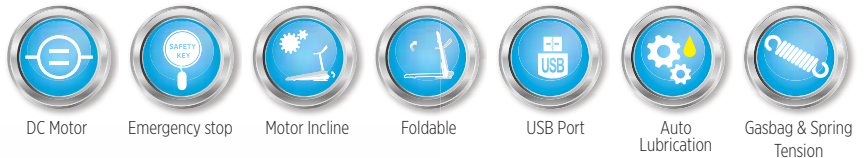

RUN 1.5

Product Code: 42143

Deluxe Treadmill with 1.25 HP DC Duty 2.5 HP Peak. Externally connected with USB and internally installed with High-Fidelity Audio.

Motor	: 1.25 HP DC Duty (2.5 HP Peak)
Speed Range	: 0.8-14 Kph.
Incline	: No Incline
Running Belt	: 17 x 48"(450 x 1220mm)
Display	: Blue LCD
Max. User Weight	: 110 Kgs.
Net Weight	: 46 Kgs.
Assembly (LxWxH)	: 1515 x 720 x 1251mm
Other Features	: Auto Lubrication System, FOUR (4) Levels Adjustable GASBAG and SPRING Shock Absorption (Patented),Bluetooth for HK Treadmill Application only.

ELECTRONICS

Functions : Hi-Fi Audio, USB, P1-P12 Programs

Displays : Time, Speed, Distance, Heart Rate, Calories, Program



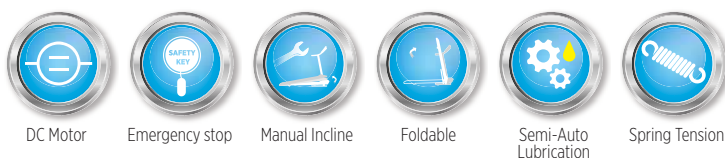

RUN 1.0

Product Code: 42121

Deluxe Treadmill with 1.25 HP DC Motor, Six-level Shock Absorption and Semi-Auto Lubrication system. Externally connected with MP3,USB;and internally installed with High-Fidelity Audio.

Motor	: 1.25 HP (2.5 HP PEAK) DC Duty
Speed Range	: 1.0-14 Kph.
Incline	: Manual Incline 3%, 5%
Running Belt	: 16 x 49" (420x1260mm)
Display	: LCD Display
Max. User Weight	: 110 Kgs.
Net Weight	: 59 Kgs.
Assembly (LxWxH)	: 1750 x 770 x 1330mm
Other Features	: 6 Level Shock Absorption Semi-Auto Lubrication System, Emergency Stop, Foldable

ELECTRONICS

Functions : Smart Memory Function, Run, Audio, HR, Bluetooth for HK Treadmill Application only. Mp3, USB, Program: P1-P12, H1, H2, H3 Mode, FAT Mode

Displays : Speed, Distance, Time, Calories, Pulse, Incline



FITLUX 583 *FitLux*

Made in Taiwan

Product Code: 42131

FitLux 583, a great motorized treadmill that combines unique design and innovative technology that fit your smart lifestyle. Looking for quality fitness equipment with amazing performance? Then look no further than FitLux 583.

Motor	: 3.0 HP (6 HP PEAK) DC Duty
Speed Range	: 0.8-18 Kph.
Incline	: Motor Incline 12%
Running Belt	: 20 x 58" (510x1470mm)
Display	: Backlit LCD 107 x 55mm
Max. User Weight	: 140 Kgs.
Net Weight	: 98 Kgs.
Assembly (LxWxH)	: 1880 x 850 x 1540mm

ELECTRONICS

Functions : ***New ASA System**, 4 LED, Quick Speed Buttons, Audio In/Out, USB Socket, 2-Speed Cooling Fan, 2 Speakers, Built-in Polar Compatible Receiver, Patented One Touch Auto Folding, 2 Holders for Cell Phone | Water Bottle, Emergency Stop, **Auto Power Fold**

Displays : Speed, Distance, Time, Calories, Lap, Program,Level, Incline



*New ASA SYSTEM - 5-Level Shock Absorption System



*New ASA SYSTEM - 5-Level Shock Absorption System

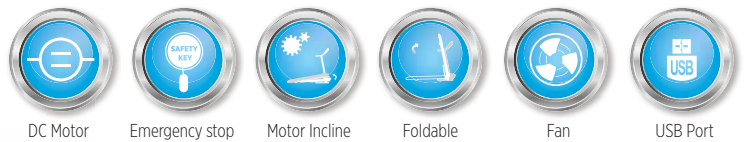

FITLUX 365 *FitLux*

Made in Taiwan

Product Code: 42132

FitLux 365, a great motorized treadmill that combines unique design and innovative technology that fit your smart lifestyle. Patented new ASA suspension system provides a new possibility to create the most pleasant workout experience.

Motor	: 2.7 HP (5.5 HP PEAK) DC Duty
Speed Range	: 0.8-16 Kmph
Incline	: Motor Incline 12%
Running Belt	: 18 x 52"(460x1320mm)
Display	: LCD Display
Max. User Weight	: 120 Kgs.
Net Weight	: 84 Kgs.
Assembly (LxWxH)	: 1700 x 780 x 1555mm
Other Features	: *New ASA System , (5 Level Shock Absorption System)

ELECTRONICS

Functions	: 2 Dot Matrix, 4 LED, 1 LCD, Fan, Quick Speed/ Incline Buttons, USB, Speaker, Built-in Heart Rate Receiver, Headphone Jack, Emergency Stop, Foldable
Displays	: Speed, Distance, Time, Calories, Lap, Program, Level, Incline,



*ASA SYSTEM - Reduces Shock Impact by 10% -30%



JK-AEROWORK 897 *JKEXER*

Made in Taiwan

Product Code: 42128

A comfy workstation and a professional treadmill are innovatively integrated by JK's patented FlipTop design for both safe working while walking and high intensive workout. The newly-launched AeroWork is here to make your dream of Work-Life Balance come true!

Motor	: 3 HP (6 HP PEAK) DC Duty
Speed Range	: 0.8-18 kph (Running Mode)0.8-6 kph(Walking Mode)
Incline	: 0-12% Motor Incline (Running Mode) Non adjustable incline (Walking Mode)
Running Belt	: 20 x 55"(510x1400mm)
Display	: 1 Back-Lit 150 x 82 mm LCD & 2 Dot Matrix
Max. User Weight	: 140 Kgs.
Net Weight	: 102 Kgs.
Assembly (LxWxH)	: 1800 x 850 x 1340mm
Other Features	: 1-Minute Tool-Free Easy Assembly

ELECTRONICS

Functions	: *ASA System , 4 Way Adjustment Desktop to fit users of All Sizes.10W USB charger,25mm Thickness Running Deck, Audio Jacks, HD Speakers, Fan, Tablet Slots, Emergency Stop, Foldable
Displays	: Speed, Distance, Incline, Calories, Time, Pulse, Level, Program, Age, Step,1 Manula, 3 HRC, 2 User, 3 Target and 12 Pre-set in 3 Levels Programs



CET-WAVE-850 E

Product Code: 42607

Elliptical Trainer with Power Resistance, designed for intensive training at home with minimum impact on joints. 8 Kgs. 2 Way Flywheel with Flat Belt Drive System provides less jerk and noise free workouts. Hand movement with Leg movement provides complete Cardio Exercise. Electronic control of Resistance ensure variety to exercises.

Flywheel	: 8 Kgs. 2 Way
Max. User Weight	: 130 Kgs.
Net Weight	: 51 Kgs.
Assembly (LxWxH)	: 1450 x 575 x 1720mm

ELECTRONICS

Displays	: Pulse, Recovery etc
----------	-----------------------

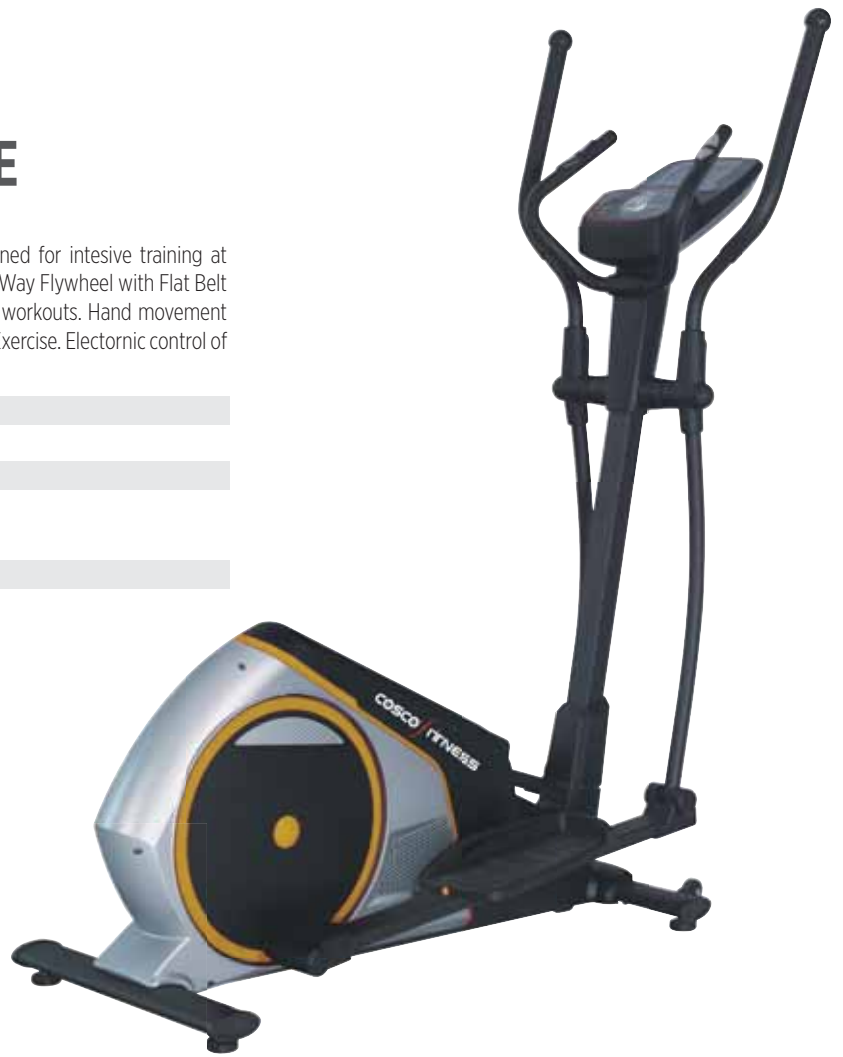

CET-WAVE 800 E

Product Code: 42608

Magnetic Elliptical Trainer with 8 Level Resistance provides impact free exercise for joints. Belt Drive System ensures jerk free workout. Longer Stride Length provides complete exercise. Hand Pulse & Recovery

Flywheel	: 7 Kgs. Two Way
Max. User Weight	: 120 Kgs.
Net Weight	: 49 Kgs.
Assembly (LxWxH)	: 1640 x 720 x 1140 mm

ELECTRONICS

Displays	: Time, Speed, Distance, Pulse & Calories
----------	---



CET-92 E

Product Code: 42616

Step-Throguh Design Elliptical Bike with 2 Way 5 Kgs. Flywheel. Stride Length 280mm(11"). Console with ipad and Phone Stand. 8 Level Manual Tension Control.

Stride Length : 280mm (11 inches)

Resistance Level : 8 Levels

Max. User Weight : 120 Kgs.

Net Weight : 40 Kgs.

Assembly (LxWxH) : 1270x670x1595mm

ELECTRONICS

Functions : 8 Level Manual Tension Control

Displays : Time, Speed, Distance, Pulse, Calories, Scan, Odo., Watt, T.H.R., Recovery, Bodyfat



with Seat

CET-80 E

Product Code: 42610

New design Elliptical Trainer with Seat can be used like elliptical bike while in standing position and cycling when seating position, 5 kgs. Heavy Flywheel, Large Non-Skid Foot Pedal, Big LCD Display monitor provides feedback on workout parameters.

Max. User Weight : 110 Kgs.

Net Weight : 30.5 Kgs.

Assembly (LxWxH) : 1155 x 750 x 1580 mm

ELECTRONICS

Displays : Time, Speed, Distance, Pulse, Calories, Scan, Odo.





WAVE-700

Product Code: 42316

Magnetic Recumbent Bike for heavy duty Home use,. It has 6 Kgs. Flywheel for smooth operation. The Sliding seat gives flexibility in adjustment to one's size. PU Moulded Bucket Seat adds ti tge comfort of the back. Mid cut design enable one to get on or off without any discomfort. 8 Level Magnetic Resistance, Hand Pulse & Recovery, Flat Belt, 3PC Crank

Flywheel : 6 Kgs.One Way (250mm Dia.)

Max. User Weight : 120 Kgs.

Net Weight : 47 Kgs.

Assembly (LxWxH) : 1560 x 720 x 1130 mm

ELECTRONICS

Displays : Time, Speed, Distance, Pulse & Calories

CEB-91 R

Product Code: 42333

Recumbent Bike with Two Ways 5 Kgs. Flywheel. Flat Belt.
8 Level Manual Tension Control.

Flywheel : 5 Kgs. Two Ways

Resistance Level : 8 Levels

Max. User Weight : 120 Kgs.

Net Weight : 36 Kgs.

Assembly (LxWxH) : 1370 x 650 x 1050mm

Other Features : Flat Belt

ELECTRONICS

Functions : 8 Level Manual Tension Control.

Displays : Time, Speed, Distance, ODO., Calorie,
Pulse, Scan



Sliding Seat

CEB-70 R

Product Code: 42318

New Design Recumbent Bike with Sliding Seat Adjustment for optimised Home use. 2 Ways 5 Kgs. Flywheel gives smooth workout. Monitor displays all the feedback parameters on BIG LCD Screen.

Flywheel : 5 Kgs. 2 Ways

Max. User Weight : 100 Kgs.

Net Weight : 35 Kgs.

Assembly (LxWxH) : 1300 x 640 x 1190mm

ELECTRONICS

Displays : Time, Speed, Distance, Pulse, Calories, Scan, Odo.

CEB-WAVE-600U

Product Code: 42319

Magnetic Upright Bike WAVE 600 U elevates performance with flat belt drive for jerk free operation and maximum power transmission. PU contour seat with seat adjustment for comfortable exercise. Big LCD for display of all workout parameters. It has 8 Level Magnetic Resistance.

Flywheel : 5.5 Kgs.(250 mm Dia.)

Max. User Weight : 120 Kgs.

Net Weight : 32 Kgs.

Assembly (LxWxH) : 1090 x 640 x 1360 mm

ELECTRONICS

Displays : Time, Speed, Distance, Pulse & Calories



CEB-90 U

Product Code: 42332

Upright Bike with 5 Kgs. One Way Magnetic Flywheel. 8 Level Manual Tension Control. Console with ipad/ Phone Stand.

Flywheel : 1 Way 5 Kgs.

Crank : 3 Pcs

Max. User Weight : 120 Kgs.

Net Weight : 28 Kgs.

Assembly (LxWxH) : 1370 x 650 x 1040mm

ELECTRONICS

Functions : 8 Level Manual Tension Control.

Displays : Time, Speed, Distance, Pulse, Calories, Scan, Odo., Watt, T.H.R., Recovery, Bodyfat



CEB-60 U

Product Code: 42322

New design programmable Upright Bike, 2 ways, 6 Kgs. Flywheel and 1 Pc Crank. 24 Programs including Bodyfat, T.H.R, H.R.C., U1-U4, iphone | ipad Stand, 24 Level Auto Tension Control. Seat height adjustment for optimal riding positions.

Crank	: 1 Pc.
Flywheel	: 6 Kgs.
Resistance Level	: 8 Level Manual Tension Control
Max. User Weight	: 100 Kgs.
Net Weight	: 25 Kgs.
Assembly (LxWxH)	: 860 x 445 x 1400mm

ELECTRONICS

Functions	: ipad, iphone Stand, 24 Programs including Bodyfat, T.H.R, H.R.C., U1-U4
Displays	: Time, Speed, Distance, Pulse, Calories, Scan, Odo., Recovery, Age

CEB-604 A

Product Code: 42321

Dual action Air Bike with Movable Handle Bar for optimal cardio workout. Big 500mm flywheel ensures smooth and effective exercises. Adjustable tension | resistance.

Flywheel	: 500 mm Dia
Net Weight	: 18 Kgs.
Max. User Weight	: 100 Kgs.
Assembly (LxWxH)	: 1050 x 540 x 1160 mm

ELECTRONICS

Displays	: Time, Speed, Distance, Pulse & Calories
----------	---



CEB-610

Product Code: 42325

Convenient and compact design ensures smaller space to store. Fan Bike with Movable Handle Bar with adjustable tension. Dual exercises for feet and hands.

Flywheel : 470mm

Max. User Weight : 80 Kgs.

Net Weight : 19 Kgs.

Assembly : 1000 x 550 x 1170 mm

ELECTRONICS

Displays : Time, Speed, Distance, Pulse & Calories



CEB-609 C

Product Code: 42324

Elliptical Bike with Movable Handle Bar. Small monitor to provide feed of your workouts. Tension adjustment for higher resistance exercises. Adjustable seat height.

Flywheel : 470mm Dia

Max. User Weight : 100 Kgs.

Net Weight : 25 Kgs.

Assembly (LxWxH) : 870 x 550 x 1550 mm

ELECTRONICS

Displays : Time, Speed, Distance, Pulse & Calories



CEB-20 U

Product Code: 42323

New sleek, small design Magnetic Bike with 4 Kgs. 2 ways Flywheel for Home use. 8 level preset resistance ensures variety of exercises. Adjustable seat for convenient use.

Crank	: 1 Pc.
Flywheel	: 4 Kgs.
Other Features	: 8 Level Manual Tension Control
Max. User Weight	: 100 Kgs.
Net Weight	: 18 Kgs.
Assembly (LxWxH)	: 850 x 490 x 1120mm

ELECTRONICS

Displays	: Time, Speed, Distance, Pulse, Calories, Scan, Odo.
----------	--



CEB-JK-3665 **JKEXER**[®]

Made in Taiwan

Product Code: 42328

This bike is furnished with all you need for practice. The ergonomics engage every domestic user, making biking at home challenging yet comfortable. The durable flywheel provides constant resistance.

RACE 3665 is your best choice of home-use racing bikes.

Center balance 20kg, 460mm (dia.) die-casting chrome plated flywheel. 3-pc cold forged steel crank with 20 mm dia. cro-moly axle & commercial grade sealed bearings. Emergency caliper braking with tension control system. Belt drive, fix-wheel system.

Flywheel	: Center balance 20 Kgs.(460mm Dia)
Max. User Weight	: 120 Kgs.
Net Weight	: 49 Kgs.
Assembly (LxWxH)	: 1200 x 600 x 1200 mm

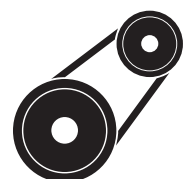



CGC-60

Product Code: 42314

Compact Group Cycling Bike to train at home with Poly V-Belt drive and friction brakes. 18 Kgs. flywheel provides smooth and noiseless workout. Racing Bike Handle provides extra versatility to exercises. Seat adjustment and handle pads add to the comfort. Monitor provides real time feedback of workout.

Flywheel	: 18 Kgs. 500 mm Dia.
Max. User Weight	: 100 Kgs.
Net Weight	: 41 Kgs.
Assembly (LxWxH)	: 1050 x 540 x 1160 mm
Other Feature	: Cycle Bend Handle , Arm Rest Pad and Meter, Belt Driven

ELECTRONICS

Displays	: Time, Speed, Distance, Pulse & Calories
----------	---

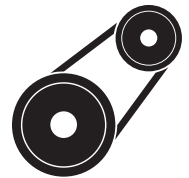

CGC-50

Product Code: 42315

Compact Group Cycling Bike with Poly V-Belt drive and friction brakes. 15 Kgs. flywheel ensures smooth and noiseless operation. Seat adjustment and handle pads add to the comfort. Monitor provides real time feedback of workout.

Flywheel	: 15Kgs. 470mm Dia.
Max. User Weight	: 100 Kgs.
Net Weight	: 36 Kgs.
Assembly (LxWxH)	: 870 x 550 x 1550 mm
Other Feature	: Arm Rest Pad and Meter, Belt Driven

ELECTRONICS

Displays	: Time, Speed, Distance, Pulse & Calories
----------	---

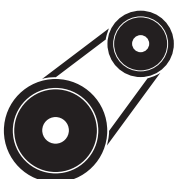



Manual Incline

CTM 510

Product Code: 42133

Manual Treadmill with Multi-function exercise to many parts of your body. Comfortable walking area and stepper for leg & hip exercises. Twister workout for the AB area. Monitor provides exercise feedback. Foldable and easy to store conveniently

Incline : 3 Level Manual Incline

Running Belt : 15 x 47"

Max. User Weight : 100 Kgs.

Net Weight : 38 Kgs.

Foldable : Yes

ELECTRONICS

Functions : 4-in 1 Manual Treadmill, Convenient Running Area. Twister, Stepper & Pushup Exercise

Displays : Speed, Distance, Time, Calories, Pulse

CRW-JK-903 JKEXER® Made in Taiwan

Product Code: 42804

Internal Roller with Beam, Sturdy Steel Frame, 360° Smooth Forward and Backward Movement. Internal Roller Tack for Comfortable Glide Padded Seat, Swivelling Foot Rest, Velcro Straps.

Max. User Weight : 110 Kgs.

Net Weight : 16 Kgs.

Assembly (LxWxH) : 1220 x 710 x 770 mm



CST-JK-468 JKEXER® Made in Taiwan

Product Code: 42802

GS Approved, Smooth Twisting Design for Safety Operation, 5 Function Meter. Optional Elastic Band

Max. User Weight : 90 Kgs.

Net Weight : 7 Kgs.

Assembly (LxWxH) : 440 x 410 x 250 mm

ELECTRONICS

Displays : Count, Time, Calorie, Scan, Strides/min



CST-JK-355 C JKEXER® Made in Taiwan

Product Code: 42803

Fashionable Moulded Front Stand. Patentend System. Transparent Pedals.

Max. User Weight : 90 Kgs.

Net Weight : 7 Kgs.

Assembly (LxWxH) : 440 x 410 x 250 mm

ELECTRONICS

Displays : Count, Time, Calorie, Scan, Strides/min



CHG-150 R

Product Code: 42805

Multi function Home Gym provides maximum exercises for strength training. It comes with 150 lbs Plastic Concrete Weight Stack which makes low noise.turdy Round Tube Frame.

Weight Stack : 150 lbs

Maximum User Weight : 150 Kgs.

Net Weight : 111 Kgs.

Assembly (LxWxH) : 1300 x 1170 x 2080 mm



HomeGym Workouts

TRICEPS PUSHDOWN

1. Stand in front of the machine with feet shoulder-width apart. Adjust the seat height so that the bar is at chest height.
2. To do the exercise, grasp the bar with both hands, grip with palms facing each other in your hands, palms may be down or to the outside. Release weight under control to starting position. Keep arms straight during the exercise. Triceps extension only against the elbow joint.

LAT PULLDOWN

1. Reach for the bar. Sit on the seat, adjust the height with roller foot. Shoulder-width grip and with hands completely in line with your feet.
2. To do the exercise, lean back and steady pull the bar down until it reaches the top of your chest.
3. To release, return the bar to the starting position.
4. To maintain posture, sit on the seat in the middle of the seat.

LEG EXTENSION

1. Adjust seat height so that the roller foot is at chest height at the end of the seat. Place feet on the foot plate.
2. To do the exercise, grasp the roller foot with both hands, palms facing each other. Pull up against the bar until your knees are straight and your feet are on the roller foot. Release weight under control to starting position.

STANDING LEG CURL

1. Tuck the chin. Sit on the seat, adjust the roller foot. Place feet on the roller foot. Grasp the roller foot with both hands, palms facing each other. Pull up against the bar until your knees are straight and your feet are on the roller foot. Release weight under control to starting position.

VERTICAL CHEST PRESS

1. Adjust seat height so that the roller foot is at chest height at the end of the seat. Place feet on the foot plate.
2. To do the exercise, grasp the roller foot with both hands, palms facing each other. Pull up against the bar until your knees are straight and your feet are on the roller foot. Release weight under control to starting position.

STANDING ARM CURL

1. Stand in front of the machine with feet shoulder-width apart. Adjust the seat height so that the bar is at chest height.
2. To do the exercise, grasp the bar with both hands, grip with palms facing each other in your hands, palms may be down or to the outside. Release weight under control to starting position. Keep arms straight during the exercise. Triceps extension only against the elbow joint.

SEATED TRICEPS EXTENSION

1. Sit on the seat, adjust the roller foot. Place feet on the roller foot. Grasp the roller foot with both hands, palms facing each other. Pull up against the bar until your knees are straight and your feet are on the roller foot. Release weight under control to starting position.

ARM CRUNCH (CABLE)

1. Sit on the seat, adjust the roller foot. Place feet on the roller foot. Grasp the roller foot with both hands, palms facing each other. Pull up against the bar until your knees are straight and your feet are on the roller foot. Release weight under control to starting position.

STANDING OUTER THIGH

1. Stand in front of the machine with feet shoulder-width apart. Adjust the seat height so that the bar is at chest height.
2. To do the exercise, grasp the bar with both hands, grip with palms facing each other in your hands, palms may be down or to the outside. Release weight under control to starting position. Keep arms straight during the exercise. Triceps extension only against the elbow joint.

HomeGym Workouts

UPRIGHT ROW

1. Stand in front of the machine with feet shoulder-width apart. Adjust the seat height so that the bar is at chest height.
2. To do the exercise, grasp the bar with both hands, grip with palms facing each other in your hands, palms may be down or to the outside. Release weight under control to starting position. Keep arms straight during the exercise. Triceps extension only against the elbow joint.

LOW ROW

1. Sit on the seat, adjust the roller foot. Place feet on the roller foot. Grasp the roller foot with both hands, palms facing each other. Pull up against the bar until your knees are straight and your feet are on the roller foot. Release weight under control to starting position.

STANDING TRICEPS EXTENSION

1. Stand in front of the machine with feet shoulder-width apart. Adjust the seat height so that the bar is at chest height.
2. To do the exercise, grasp the bar with both hands, grip with palms facing each other in your hands, palms may be down or to the outside. Release weight under control to starting position. Keep arms straight during the exercise. Triceps extension only against the elbow joint.

BUTTERFLY

1. Adjust the roller foot so that the roller foot is at chest height at the end of the seat. Place feet on the roller foot. Grasp the roller foot with both hands, palms facing each other. Pull up against the bar until your knees are straight and your feet are on the roller foot. Release weight under control to starting position.

PECTORAL CONTRACTOR

1. Adjust the roller foot so that the roller foot is at chest height at the end of the seat. Place feet on the roller foot. Grasp the roller foot with both hands, palms facing each other. Pull up against the bar until your knees are straight and your feet are on the roller foot. Release weight under control to starting position.

BUSTED RAISE

1. Adjust the roller foot so that the roller foot is at chest height at the end of the seat. Place feet on the roller foot. Grasp the roller foot with both hands, palms facing each other. Pull up against the bar until your knees are straight and your feet are on the roller foot. Release weight under control to starting position.

SIDE BEND

1. Adjust the roller foot so that the roller foot is at chest height at the end of the seat. Place feet on the roller foot. Grasp the roller foot with both hands, palms facing each other. Pull up against the bar until your knees are straight and your feet are on the roller foot. Release weight under control to starting position.

BACK KICK

1. Stand in front of the machine with feet shoulder-width apart. Adjust the seat height so that the bar is at chest height.
2. To do the exercise, grasp the bar with both hands, grip with palms facing each other in your hands, palms may be down or to the outside. Release weight under control to starting position. Keep arms straight during the exercise. Triceps extension only against the elbow joint.

STANDING INNER THIGH

1. Stand in front of the machine with feet shoulder-width apart. Adjust the seat height so that the bar is at chest height.
2. To do the exercise, grasp the bar with both hands, grip with palms facing each other in your hands, palms may be down or to the outside. Release weight under control to starting position. Keep arms straight during the exercise. Triceps extension only against the elbow joint.



CSB 15

MULTI FUNCTIONAL BENCH DELUXE

Product Code: 28805

Description : Tube Size 76X1.5mm, Adjustable
Dim. : 168x110x125-136cms

CSB 13

MULTI FUNCTIONAL BENCH ECO

Product Code: 28804

Description : Tube Size 50X50x1.5mm, Adjustable
Dim. : 145x140x108cms



CSB 10

MULTI FUNCTIONAL BENCH

Product Code: 28801

Description : Tube Size 50X50x1.5mm, Adjustable
Dim. : 120x62x51-125cms

CSB 58 FLAT BENCH

Product Code : 28802

Description : Tube Size 38X38x1.5mm, Adjustable
Dim. : 112x38x40-115cms



CSB 3 ABDOMINAL BOARD

Product Code : 28800

Description : Tube Size 50X50x1.5mm, Adjustable
Dim. : 132x32x60-75cms

CSB 8 AB EXERCISER

Product Code: 28803

Description : Tube Size 38X38x1.5mm, Adjustable
Dim. : 112x38x40-115cms



AB ROLL-X

Product Code : 28097

Description : For AB exercised and crunches

KETTLE BELL DUMBBELL



2 KGS

Code : 28207



3 KGS

Code : 28208



4 KGS

Code : 28200



6 KGS

Code : 28201



8 KGS

Code : 28202



10 KGS

Code : 28203



12 KGS

Code : 28204



16 KGS

Code : 28205



20 KGS

Code : 28209



*KETTLE BELLS ARE NOT INCLUDED

KETTLE BELL RACK

Code : 28089

Description : IMPORTED KETTLE BELL Dumbbell Stand, Made from 8cm x 4cm Elliptical Tubing for Superior Strength, 3 tier Sturdy construction Display Rack that hold 5 pieces of ergo Kettle Bell, Large 15cm x 10cm Foot Plates to spread the Weight of Fully Loaded Rack, Simple yet Sturdy Bolt together Design, Powder Coated in a durable Crinkle Black Finishing.

Material : Iron | **Size** : 42 x 39 x 73 cm
Colour : Black

HEXAGONAL VINYL DUMBBELL



1 KG

Code : 28100



2 KGS

Code : 28102



3 KGS

Code : 28104



4 KGS

Code : 28105



5 KGS

Code : 28106

ROUND DUMBBELL



2.5 Kgs

Code : 28400



5 Kgs

Code : 28401



7.5 Kgs

Code : 28402



10 Kgs

Code : 28403



12.5 Kgs

Code : 28404



15 Kgs

Code : 28405



20 Kgs

Code : 28406



25 Kgs

Code : 28407



30 Kgs

Code : 28408



40 Kgs

Code : 28409

HEXAGONAL RUBBER DUMBBELL



Code : 28307

Weight 20 Kg.

Code : 28306

Weight 15 Kg.

Code : 28305

Weight 12½ Kg.

Code : 28304

Weight 10 Kg.

Code : 28303

Weight 7½ Kg.

Code : 28301

Weight 2½ Kg.

Also Available in : 1 Kg. (28300), 5 Kg. (28302), 25 Kg. (28308), 30 Kg. (28309), 40 Kg. (28310), 50 Kg. (28311)



50mm

STEEL ROD OLYMPIC

7 Ft. (28615), 6 Ft. (28616), 5 Ft. (28617), 4 Ft. (28618)



30mm

STEEL ROD REGULAR THREADED

7 Ft. (28600), 6 Ft. (28602), 5.8 Ft. (28604), 5 Ft. (28605), 4 Ft. (28607)



30mm

STEEL ROD REGULAR WITHOUT THREAD

7 Ft. (28601), 6 Ft. (28603), 5 Ft. (28606), 4 Ft. (28608)



TRICEP CURL BAR THREADED

Code : 4 Ft. (28613)



EZ CURL BAR THREADED

Code : 4 Ft. (28614)



WEIGHT CLIP-REGULAR 50 mm

Code : (28619)



WEIGHT CLIP-REGULAR 30 mm

Code : (28620)



SOLID BAR WITHOUT THREAD

2.1 Ft. (28610), 1.4 Ft. (28611), 1.2 Ft. (28612)



SOLID BAR THREADED

2.1 Ft. (28609)

WEIGHT PLATES



Inner Diameter 30 mm

Inner Diameter 50 mm



Available in : 1¼ Kg. (28500), 2½ Kg. (28501), 5 Kg. (28502), 7½ Kg. (28503), 10 Kg. (28504), 15 Kg. (28505), 20 Kg. (28506), 25 Kg. (28507)

Available in : 1¼ Kg. (28700), 2½ Kg. (28701), 5 Kg. (28702), 7½ Kg. (28703), 10 Kg. (28704), 15 Kg. (28705), 20 Kg. (28706), 25 Kg. (28707)



DELHI | GURUGRAM | MUMBAI | JALANDHAR

COSCO (INDIA) LIMITED

2/8 Roop Nagar, Delhi-110007, Tel.: +91 11 23843000

Tel.: +91 11 23843000 | Fax: +91 11 23846000 | E-mail: mail@cosco.in

www.cosco.in | Online Store : <https://store.cosco.in>

   /coscoindia